

1538-A Strobotac
Electronic Stroboscope
User and Service Manual



Copyright © 2001 IET Labs, Inc.

1538-A im/March, 2002



IET LABS, INC.

Standards • Decades • Strobes • Sound Level Meters • Bridges

Formerly manufactured by

GenRad

534 Main Street, Westbury, NY 11590

TEL: (516) 334-5959 • (800) 899-8438 • FAX: (516) 334-5988

www.ietlabs.com

WARRANTY

We warrant that this product is free from defects in material and workmanship and, when properly used, will perform in accordance with applicable IET specifications. If within one year after original shipment, it is found not to meet this standard, it will be repaired or, at the option of IET, replaced at no charge when returned to IET. Changes in this product not approved by IET or application of voltages or currents greater than those allowed by the specifications shall void this warranty. IET shall not be liable for any indirect, special, or consequential damages, even if notice has been given to the possibility of such damages.

THIS WARRANTY IS IN LIEU OF ALL OTHER WARRANTIES, EXPRESSED OR IMPLIED, INCLUDING BUT NOT LIMITED TO, ANY IMPLIED WARRANTY OF MERCHANTABILITY OR FITNESS FOR ANY PARTICULAR PURPOSE.



WARNING



OBSERVE ALL SAFETY RULES
WHEN WORKING WITH HIGH VOLTAGES OR LINE VOLTAGES.

**Dangerous voltages may be present inside this instrument. Do not open the case
Refer servicing to qualified personnel**

HIGH VOLTAGES MAY BE PRESENT AT THE TERMINALS OF THIS INSTRUMENT

WHENEVER HAZARDOUS VOLTAGES (> 45 V) ARE USED, TAKE ALL MEASURES TO
AVOID ACCIDENTAL CONTACT WITH ANY LIVE COMPONENTS.

USE MAXIMUM INSULATION AND MINIMIZE THE USE OF BARE
CONDUCTORS WHEN USING THIS INSTRUMENT.

Use extreme caution when working with bare conductors or bus bars.

WHEN WORKING WITH HIGH VOLTAGES, POST WARNING SIGNS AND
KEEP UNREQUIRED PERSONNEL SAFELY AWAY.



CAUTION



DO NOT APPLY ANY VOLTAGES OR CURRENTS TO THE TERMINALS OF THIS
INSTRUMENT IN EXCESS OF THE MAXIMUM LIMITS INDICATED ON
THE FRONT PANEL OR THE OPERATING GUIDE LABEL.

Contents

Section 1

| | |
|---|----------|
| INTRODUCTION | 1 |
| 1. General Description of a Stroboscope | 1 |
| 1.1. What it is | 1 |
| 1.2 How it works | 1 |
| 1.3 The Type 1538 Strobotac® Electronic Stroboscope | 2 |
| 1.3.1 General Description | 2 |
| 1.3.2 Controls and Connectors | 2 |
| 1.3.3 Accessories Supplied | 4 |
| 1.3.4 Accessories Available | 4 |

Section 2

| | |
|--|----------|
| OPERATING PROCEDURE | 6 |
| 2.1 Opening the Case | 6 |
| 2.2 Closing the Case | 6 |
| 2.3 Power Requirements | 6 |
| 2.3.1 Power-Line Operation | 6 |
| 2.3.2 Battery Operation | 7 |
| 2.3.3 Type 1538-P3 A Battery Source and Charger | 7 |
| 2.4 Turning the Instrument On | 8 |
| 2.5 Positioning the Stroboscope | 8 |
| 2.6 Adjusting the Flashing Rate | 8 |
| 2.7 Calibration | 8 |
| 2.8 Speed Measurements | 9 |
| 2.8.1 Fundamental-Speed Measurement | 9 |
| 2.8.2 Submultiple Speed Measurements | 10 |
| 2.8.3 Measurement of Speeds above 150,000 RPM | 10 |
| 2.8.4 Low-Speed Operation | 11 |
| 2.8.5 Slow-Motion Studies | 11 |
| 2.9 Type 1538-P2 Extension Lamp | 11 |
| 2.10 External Synchronization | 12 |
| 2.10.1 Use of the Input Jack | 12 |
| 2.10.2 Type 1531-P2 Flash Delay and type 1536 Photoelectric Pick-off | 12 |
| 2.10.3 Type 1537 Photoelectric Pick-off | 13 |
| 2.10.4 Type 1539 Stroboslave | 13 |
| 2.10.5 Use of Multiples Stroboscopes | 13 |
| 2.10.6 Connecting the Accessory Instruments | 13 |
| 2.11 High-Speed Photography | 14 |
| 2.11.1 General | 14 |
| 2.11.2 Flash Duration | 14 |
| 2.11.3 Beam | 14 |
| 2.11.4 Spectral Characteristics | 14 |
| 2.11.5 Exposure Data | 15 |
| 2.11.6 Single-Flash Photography | 15 |
| 2.11.7 Type 1538-P4 High-Intensity-Flash Capacitor | 15 |

Section 3

PRINCIPLES OF OPERATION 17
3.1 General 17
3.2 The Strobotron Tube 17
3.3 The Charging Circuit 17
3.4 The Calibration Circuit 19

Section 4

SERVICE AND MAINTENANCE 20
4.1 Customer Service 20
4.2 Instrument Return 20
4.3 Minimum Performance Standards 20
4.3.1 General 20
4.3.2 Equipment Required 20
4.3.3 Preliminary Check 20
4.3.4 Flashing-Rate Accuracy Check 21
4.3.5 Input Check 21
4.3.6 Output Check 21
4.4 Maintenance 21
4.4.1 Case Will Not Lock Properly 21
4.4.2 Cleaning the Reflector 21
4.4.3 Removing the Instrument from its Case 21
4.4.4 Replacing the Fuse 21
4.4.5 Replacing the Strobotron Lamp 21
4.4.7 Repositioning the RPM Dial and Knob 22
4.4.8 Converting to the other Power-Line Voltage 22
4.5 Trouble Analysis 23
4.5.1 Strobotron Lamp does not Flash 23
4.5.2 Strobotron Lamp Flashes Erratically 24
4.5.3 Improper Operation with External Input 25
4.5.4 Improper Operation with Battery Power 25
4.5.5 Type 1538-P2 External Lamp does not Flash; Front-Panel Strobotron Lamp Flashes 25
4.6 Replacement of Mechanical Parts 26
4.6.1 General 26
4.6.2 Reflector and Cover 26
4.6.3 Swivel-Support Assembly, Pivot Blocks, and Washers 26
4.6.4 Scale Mask Assembly 27
4.6.5 Dial 27
Type 1538-P4 High-Intensity-Flash Capacitor (See Figure 2-14) 33
Type 1538-P2 Extension Lamp 33

Figures

| | |
|---|----|
| Figure 1-1. The stroboscope can be mounted on a standard camera tripod. | 2 |
| Figure 1-2. The front panel of the stroboscope, showing the controls and connectors. | 2 |
| Figure 1-3. The Type 1538, powered by the Type 1538-P3 Battery pack, offers a precise bright stroboscope capability completely independent of the ac power line. A unique advantage in use with large machine complexes such as found in textile and printing industries. The battery pack can power the Strobe for up to 8 hours of intermittent use. | 5 |
| Figure 2-1 The transformer terminals on the stroboscope are numbered as shown. | 7 |
| Figure 2-2. Typical charge- retention characteristics of the battery. | 8 |
| Figure 2-3. Stroboscopic images produced by a rotating gear. | 10 |
| Figure 2-4. Type 1538-P2 Extension Lamp. | 12 |
| Figure 2-5. A widely used combination consists of the stroboscope with the Type 1531-P2 Flash Delay and the Type 1536 Photoelectric Pick-off. | 13 |
| Figure 2-6. Some of the many possible combinations of the Type 1538 Strobotac electronic Stroboscope and its accessory instruments. | 13 |
| Figure 2-8. Spectral distribution of the Strobotron's light output. | 14 |
| Figure 2-7. Plot of light intensity vs time of the Type 1538 Stroboscope. | 14 |
| Figure 2-10. The Type 1538-P4 High-Intensity-Flash Capacitor can be used with the Strobotac for short, single flashes. | 15 |
| Figure 2-11. Circuit of type 1538-P4 High-Intensity-Flash Capacitor. | 16 |
| Figure 3-1. Voltage-vs-time characteristics of various charging circuits. | 18 |
| Figure 3-2. Charging circuit of the Type 1538 Strobotac electronic stroboscope. | 18 |
| Figure 3-3. Block diagram of the Type 1538 Strobotac electronic stroboscope. | 18 |
| Figure 3-4. The voltage buildup on the charging capacitor is in small steps. | 19 |
| Figure 4-1. The power-supply etched-circuit board is pivoted to swing out when screws A and B are removed. | 22 |
| Figure 4-2. The power-supply board swung out to expose the under side, the fuse, and the dial lamp. | 22 |
| Figure 4-3. Right-side interior view of the Stroboscope. | 23 |
| Figure 4-4. Voltage waveform at the panel OUTPUT jack (24,000 RPM). | 24 |
| Figure 4-5. Voltage waveform at A.T.65 (24,000 RPM). | 24 |
| Figure 4-6. Voltage waveform at pin # 3 of the panel EXT LAMP socket, S0901 (24,000 RPM). | 25 |
| Figure 4-7. Voltage waveform at A.T.23 (24,000 RPM). | 25 |
| Figure 4-8. Voltage waveform at A.T.63 (24,000 RPM). | 25 |
| Figure 4-9. Miscellaneous part numbers. | 26 |
| Figure 4-10. Interior view showing mounting of the swivel-support assembly, pivot blocks, and connections. . | 26 |
| Figure 4-11. Name and location of parts included in the IET Flip-Tilt Case (refer to table 4-1). | 27 |
| Figure 4-12. Power supply etched-board assembly. (Complete assembly is P/N 1538-2751). | 28 |
| Figure 4-13. Oscillator etched-board assembly. (Complete assembly in P/N 1538-2710.) | 28 |
| Figure 4-14. Switch-circuit etched-board assembly. (Complete assembly is P/N 1538-2721.) | 28 |
| Some of the many accessory instruments available for use with the stroboscopes. | 33 |

Appendix

| | |
|--|----|
| Type 1539-A Stroboslave and Specifications | 34 |
| Type 1531-P2 Flash Delay and Specifications | 34 |
| Type 1536-A Photoelectric Pickoff and Specifications | 35 |
| Type 1537-A - Photoelectric Pickoff and Specifications | 35 |

Section 1

INTRODUCTION

NOTE

The IET Handbook of Stroboscopy describes in detail many stroboscopic techniques and applications.

1. General Description of a Stroboscope

1.1. What it is

A stroboscope is a source of flashing light that can be synchronized with any fast, repeating motion so that a rapidly moving device seems to stand still, or to move slowly.

1.2 How it works

To understand how the stroboscope stops or slows down motion, consider a fan rotating at 1800 revolutions per minute, and a light that is switched on and off 1800 times a minute (i.e., a stroboscope). Since the time between flashes is the time it takes the fan to make one revolution, every time the light flashes, the fan blades are exactly where they were the previous time. The blades are never seen in any other position; thus it appears that the fan isn't moving at all. (The retina of the eye holds one image until the next flash, so there is little, if any, flicker.) If the light is switched on and off 1801 times a minute (with the fan still turning at 1800 rpm), it is flashing faster than the fan is turning. Therefore, each time the light comes on, the fan blades have not quite reached the position they were in the previous time the light was on. The fan is seen at progressively earlier parts of its cycle and therefore it appears to be turning very slowly backward. In like manner, if the light flashes 1799 times a minute, it shows the fan blade at successively later parts of its cycle, so that the fan appears to be moving very slowly forward.

The following example illustrates this principle:

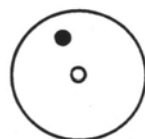

A white disc, with a single black dot, is mounted on the shaft of a 1200-rpm motor.



When the disc is rotating at 1200 rpm, it is impossible for the human eye to distinguish a single image and the dot appears to be a blurred continuous circle.



When the disc is illuminated by the flashing Strobotac® light, which is synchronized to flash once every revolution of the disc (when the dot is at 3 o'clock, for example), the dot will be seen at this position - and only at this position - at a rate of 1200 times each minute. Thus, the dot will appear to "freeze" or stand still.



Now, if the flashing rate of the stroboscope is slowed to 1199 flashes per minute, the dot will be illuminated at a slightly different position each time the disc revolves, and the dot will appear to move slowly in the direction of rotation, through 360° and arrive back at its original position (3 O'clock) one minute later.



A similar movement, but in a direction opposite to the rotation of the dot, will be observed if the flashing rate of the stroboscope is increased to 1201 rpm. If desired, the rate of apparent movement of the dot can be speeded up by further increasing or decreasing the stroboscope flashing rate.

If the flashing rate of the stroboscope is known, this is also the speed of a moving device made to “stop” under the stroboscope’s light. Thus, the stroboscope has the dual purpose of measuring speed and of apparently slowing down or stopping rapid motion, for observation. The practical significance of the slow-motion effect is that, since it is a true copy of the high-speed motion, all irregularities (vibration, torsion, chatter, whip present in the high-speed motion can be viewed and studied (refer to paragraph 2.8.5).

1.3 The Type 1538 Strobotac® Electronic Stroboscope

1.3.1 General Description

Supplementing the basic Type 1531 Strobotac® electronic stroboscope is the Type 1538 (Figure 1-1). In addition to providing a much higher flashing rate than its predecessor, the Type 1538 can be operated from an accessory battery pack or from the power line. It can be used with the Type 1538-P2 Extension Lamp to illuminate hard-to-reach areas. With the plug-in High-Intensity-Flash Capacitor Type 1538-P4, very short flashes of light of 44 million beam candles can be produced for single-flash photography applications. The Type 1538 is a small, portable stroboscope, housed in a General Radio flip-tilt case. This case serves as a tilting base when the stroboscope is in use and protects the instrument during storage and in transit. The cover of the case is permanently attached to the instrument, and the base contains a tripod mounting socket. The stroboscope can be held in the hand, placed on a convenient flat surface, or mounted on a tripod as in Figure 1-1.

In the stroboscope, the flashing rate of the tube is governed by the frequency of an internal generator, which is adjusted by means of the RPM controls, a bar knob, and a large-diameter dial. The knob selects any of four direct-reading RPM ranges; the dial is concentric with the bar knob and provides precise setting of the flashing rate. The screwdriver-adjust potentiometers on the panel are used to set the calibration at the low and high ends of the dial.

The flashes of a neon light on the panel serve as an indicator for calibration.



Figure 1-1. The stroboscope can be mounted on a standard camera tripod.

The strobotron lamp is mounted on a swivel arm and the reflector can be rotated about the lamp, which makes it possible to aim the light beam in almost any direction. The high-intensity lamp provides adequate illumination for most objects, even in normal ambient light.

When not in use, the detachable ac power cable is wound around the reflector and the range-switch knob (refer to paragraph 2.2).

1.3.2 Controls and Connectors

All controls and connectors are located on the front panel of the instrument (see Figure 1-3). The type and function of each are given in Table 1-1.

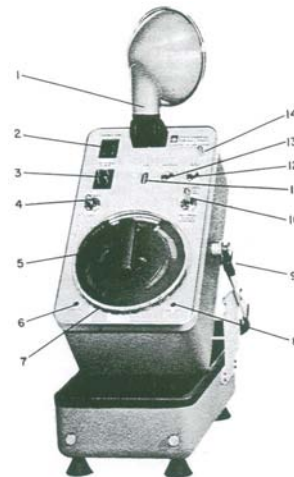

Figure 1-2. The front panel of the stroboscope, showing the controls and connectors.

Table 1-1
Controls, Connectors, and Indicators

Figure 1-3

| <u>Reference</u> | <u>Name</u> | <u>Type</u> | <u>Function</u> |
|------------------|--|---|---|
| 1 | None | Reflector and swivel arm of Strobotron lamp assembly. | Can be rotated to aim the light beam. |
| 2 | EXT LAMP | 4-prong socket | Provides a panel connection for the Type 1538-P2 Extension Lamp or the Type 1538-P4 High-Intensity Flash Capacitor. |
| 3 | 115 V 50-60 Hz 24 VDC | 4-prong plug | Accepts the power cable from the power line or from the Type 1538-P3 Battery and Charger. |
| 4 | POWER (ON-OFF) | 2-position toggle switch | Turns instrument ON or OFF. |
| 5 | RPM range switch | 5-position rotary switch | Selects any of the four RPM ranges or the CAL range. |
| 6 | LOW CAL control through panel | Screwdriver the RPM dial. | Calibrates the low end of |
| 7 | RPM dial | 4-inch dial with fluted rim | Sets the frequency of the internal oscillator. It is calibrated directly in revolutions per minute. |
| 8 | HIGH CAL | Screwdriver control through panel | Calibrates the high end of the RPM dial. |
| 10 | FLASH CONTROL (EXTERNAL- INTERNAL) | 2-position toggle switch | Selects a signal from either the internal generator or one applied externally at the INPUT jack. |
| 11 | CALIBRATE | Neon lamp | Its flashing indicates the correct setting of the CAL potentiometers for calibration of the RPM dial. |
| 12 | INPUT | Phone jack | Connects the stroboscope to an external synchronizing signal from either an electrical device or a mechanical contactor |
| (refer | | | to paragraph 2.10.1). |
| 13 | OUTPUT | Phone jack | Trigger pulse is available at this jack for triggering accessory instruments (refer to paragraph 2.10.8). |
| 14 | None | 1/2-inch pin (3/16-inch diameter) | Serves as a holding device for the ac power-cable plug when the instrument is not in use (refer to paragraph 2.2). |

1.3.3 Accessories Supplied

Supplied with the stroboscope are:
 4270-1100 - Phone plug for INPUT or OUTPUT jack
 1538-0420- Ac power cable

1.3.4 Accessories Available

The accessories listed in Table 1-2 are available for use with the stroboscope. They are described elsewhere in this book, as noted in the table.

Figure 1-4 shows a typical setup, using the stroboscope with the pick-off, the flash delay, and the Stroboslave.

-Table 1.2-
Available Accessories for the Type 1538 Stroboscope

| Type No. | Name | Function |
|----------|--------------------------------|---|
| 1538-P3 | Battery and Charger | Offers rechargeable 24-Volt dc battery-power option (paragraph 2.3.3). |
| 1538-P2 | Extension Lamp | Operates up to 6 feet from stroboscope (paragraph 2.9). Longer cords available on special order. |
| 1531-P2 | Flash Delay | Provides continuously adjustable time delay between external trigger pulse and stroboscope flash (paragraph 2.10.2). |
| 1536 | Photoelectric Pick-off | With the Type 1532-P2 Flash Delay and the stroboscope, permits analysis of motion of objects rotating at relatively steady speeds (paragraph 2.10.2). |
| 1537 | Photoelectric Pick-off | Similar to Type 1536 Pick-off, but with no light source (paragraph 2.10.3). |
| 1539 | Stroboslave | A small stroboscope without internal oscillator (paragraph 2.10.6). |
| 1538-P4 | High-Intensity-Flash Capacitor | Increases light output 10 times for single-flash photographic applications (paragraph 2.11.7). |



Figure 1-3. The Type 1538, powered by the Type 1538-P3 Battery pack, offers a precise bright stroboscope capability completely independent of the ac power line. A unique advantage in use with large machine complexes such as found in textile and printing industries. The battery pack can power the Strobe for up to 8 hours of intermittent use.

Section 2

OPERATING PROCEDURE

2.1 Opening the Case

To open the Flip-Tilt case:

- a. Set the instrument on a flat surface so that it rests on its rubber feet.
- b. Unlock the case by sliding the two gray latch blocks, (one on each side of the case) away from the handle. (It may be necessary to push down on the top of the instrument to release the latch blocks).
- c. Using the palm of the hand, push the handle down as far as possible. With the other hand, swing the instrument to the desired angle. Lower the instrument onto the rubber gasket by slowly releasing the handle. The instrument will be held in position at any angle from vertical to about 30° by its friction against the gasket. However, the case is not locked in place and it may not stay in a tilted position under severe vibration. If the instrument is to be hand-held, nestle the case into the cover and lock it in by sliding the latch blocks toward the handle.
- d. Disengage the 3-terminal ac-power-cable plug and unwind the cable from around the range-switch bar knob and the reflector.
- d. To secure the cable end, slide the 3-wire plug onto the 1/2-inch pin on the panel.
- e. To complete the closing of the case, push down slightly on the handle of the case with one hand, and with the Other swing the instrument so that the panel is facing down. Lower the instrument onto the rubber gasket by slowly releasing the handle. Apply light pressure on the top of the case and slide the two gray latch blocks toward the handle to lock the case.

2.2 Closing the Case

To close the case for storage or transit of the instrument, proceed as follows:

- a. Set the range-switch knob to the 4000-25000 RPM position.
- b. Turn the reflector down against the panel, facing up.
- c. Push the 4-prong socket at one end of the ac power cable onto the panel power plug and wind the cable in a counterclockwise direction around the range-switch bar knob and the reflector.

2.3 Power Requirements

2.3.1 Power-Line Operation

The Type 1538 Strobotac electronic stroboscope can be operated from a 115- or 230-Volt, 50- to 60-Hz or 400-Hz line, as well as from a 24-Volt dc supply. For line operation, one end of the ac power cable (P/N 1538-0420) mates with the 4-prong plug (labelled 115 V 50-60 Hz/24 VDC) on the panel and is locked in place by the two attached clips. (To unlock the clips, squeeze them toward each other with thumb and forefinger.)

The input line voltage for which the instrument is wired is noted on the panel, directly above the power plug. To change from 115-Volt to 230-Volt operation, remove the two jumpers on transformer T501 between terminals 1 and 3 and terminals 2 and 4, and add a jumper between terminals 2 and 3 (see Figure 2-1). Replace the AC Power Plug with the correct plug for your location. A 0.25- ampere fuse is used for either line voltage. To indicate a change to 230-volt operation, order an input power plate, P/N 1538-8110, from IET Labs. This plate, marked 230 V, 50-60 Hz, 24 VDC, can be cemented onto the panel over the 115-V marking.

To change the instrument from 230- to 115-volt operation, remove the jumper on transformer T501 between terminals 2 and 3 and add jumpers between terminals 1 and 3 and terminals 2 and 4 (see Figure 2-1). Always be sure the power to be applied corresponds with the panel marking above the panel power plug. The male end of the power cable has three terminals. The third pin (ground) on the power plug has been added for the safety of the operator; it should not be disconnected. If a 2-way adaptor must be used, be sure the instrument is properly grounded.

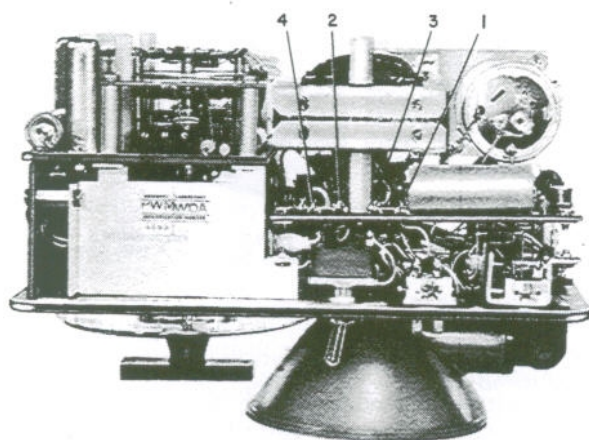

Figure 2-1 The transformer terminals on the stroboscope are numbered as shown.

2.3.2 Battery Operation

The stroboscope will also operate on 24 volts dc. The Type 1538-P3 Battery and Charger is recommended for this type of operation (see paragraph 2.3.3). The dc power also is applied at the 4-prong plug on the panel, and is controlled by the ON-OFF, POWER switch. The 0.25-ampere fuse in the stroboscope is not in the circuit for dc operation, but protection is maintained by the 1-ampere fuse mounted on the battery case.

The Type 1538 cannot be calibrated when operating on dc power. Calibration on ac (refer to paragraph 2.7) is valid for both ac and dc operation and will hold for a long period of time.

2.3.3 Type 1538-P3 A Battery Source and Charger

The Type 1538-P3 A Battery and Charger is available as an optional accessory for the Type 1538 stroboscope. It includes a rechargeable nickel-cadmium battery and an automatic battery charger mounted together in a carrying case. The battery cable is permanently attached to the unit. For battery operation, simply mate the four-contact connector on the end of the output cable with the 4-prong plug (labelled 115 V 50-60 Hz/24 Vdc) on the panel of the stroboscope. The cable is locked to the panel by the two clips on the connector; to remove the cable, press the clips toward each other with thumb and forefinger. To charge the battery, plug the unit's power cord into the AC line. The 1538-P3 can be ordered, or modified for, 220 V operation in the same manner as the 1538.

THE BATTERY

The battery consists of 20 sealed cylindrical Ni-Cd cells, which supply 24 volts at 2.3 ampere-hours. The cells incorporate a resealing, safety vent mechanism that will not open during normal battery usage but, should excessive gas pressure build up within the cell, the vent opens at a predetermined internal pressure. This pressure buildup causes distortion of the O-ring and creates a path to the atmosphere. When pressure within the cell returns to atmospheric pressure, the O-ring returns to its original shape and position and reseals the opening.

THE CHARGER

The charger included in the Type 1538-P3 A Battery Source and Charger is a constant-current type with microprocessor-controller charging and supervision. One end of the power-line cable is permanently attached to the charger.

When the battery is fully charged the charger will switch automatically to trickle charge, which will continue until it is unplugged from the ac line. When first received, the battery should be charged for about 10 hours. A completely discharged battery can be charged to 70% of full capacity in 10 hours. A fully charged battery will power the Type 1538 for about 8

hours of normal, intermittent operation, after which a 10-hour, overnight charge should be adequate to return the battery to 100% capacity. If the maximum operating time has been approached, a full 14-16 hours will be required to recharge the battery to full capacity. With no warm-up time required by the Type 1538, the POWER switch should always be turned OFF when the instrument is not in use, to conserve the charge. Although the life of the battery cells may be somewhat shortened by continual overcharging in the constant-current mode, they can be left on trickle charge for an indefinite period. The cell life of the battery is reduced by repeated complete or nearly complete discharging of the battery, or by severe overcharging. Under average operating conditions, the number of charge/discharge cycles may exceed 5000 before replacement of the battery becomes necessary. However, if the battery is deeply discharged, a cycle life as low as 300 may result. If the state of charge of the battery is unknown, recharge it for ten hours. Continuous trickle charging will maintain 100% capacity of the battery during prolonged storage periods. The battery will discharge with time if trickle charging is not used; the rate of discharge depends on the storage temperature, as shown in Figure 2-2.

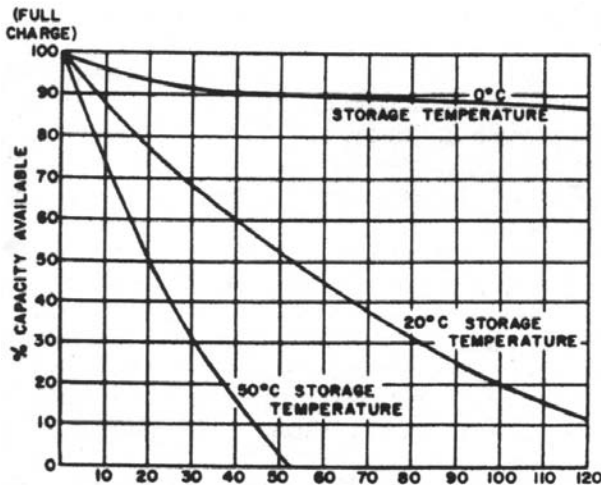

Figure 2-2. Typical charge-retention characteristics of the battery.

2.4 Turning the Instrument On

After connecting the power cable to the power line, or connecting the 1538-P3 to the instrument, pivot the reflector assembly to an upright position and turn the POWER switch ON. The stroboscope is ready for use immediately.

2.5 Positioning the Stroboscope

The light beam can be aimed in almost any direction by means of the swivel arm and the rotating reflector (1, Figure 1-2). The intensity of the light pulse is so high and the beam angle is so small that it is usually not necessary to place the unit close to the object being viewed. If the instrument is to be held in a fixed position for a long period of time, a tripod or other support should be used.

2.6 Adjusting the Flashing Rate

The flashing rate of the strobotron lamp is adjusted by means of the RPM range-switch knob and the RPM dial (5 and 7, Figure 1-2). The total range of the stroboscope is divided into four overlapping ranges selected by the range-switch knob. The limits for each range are marked near the appropriate window in the range mask. The windows on the mask reveal only the range in use.

To operate the RPM dial, turn the fluted, transparent rim that surrounds the range-switch mask. The red indicator line over the dial scale gives the speed setting in flashes per minute (corresponding to rpm) for speed measurements.

2.7 Calibration

To use the stroboscope for the most accurate measurements of speed, the RPM dial can be calibrated using the frequency of the ac power line. The calibration is then valid for either ac or battery operation. There is no provision for calibrating the instrument on battery power.

To calibrate the Type 1538, proceed as follows:

- a. Allow the instrument to warm up for at least ten minutes.
- b. Turn the RPM range switch to the CAL position.
- c. Set the RPM dial to 3600* (60 cycles/second x 60 seconds/minute) by rotating it until the mark at 3600* is exactly under the red indicator line.
- d. Adjust the panel screwdriver control marked HIGH CAL until the flashing of the neon CALIBRATE lamp stops (or nearly stops). The lamp may remain on, off, or barely on, but it should not be changing. The longer the time required for the lamp to complete one cycle — from on to off, then on again — the closer the setting of the potentiometer is to an exact calibration. For example, if the CALIBRATE lamp takes two seconds to complete one full cycle, with the RPM dial set at 3600, the error in the dial calibration is:

$$\frac{3600^* \text{ rpm}}{60 \text{ cycles/sec} \times 2 \text{ sec/cycle}} = 30 \text{ cycles/min (rpm)}$$

NOTE

Do not confuse the characteristic flicker on low ranges with the on-off action referred to here. When the CAL setting is very close to the power-line frequency, the CAL lamp will vary in intensity very slowly.

- e. Set the RPM dial to 900** and repeat step d, using the LOW CAL screwdriver adjustment on the front panel. On this range, for example, a two-second flashing period of the CALIBRATE lamp represents an error of:

$$\frac{900 \text{ rpm}}{60 \text{ cycles/sec} \times 2 \text{ sec/cycle}} = 7.5 \text{ cycles/min (rpm)}$$

- f. Return the RPM dial to 3600* and repeat the procedure of step d until the CALIBRATE lamp is flashing very slowly or not at all. (This step is not necessary unless the LOW CAL adjustment was changed significantly.)
- g. In general, it is not necessary to return to the 900** RPM point to repeat the procedure unless a very precise calibration is required. The RPM dial is now calibrated to within ± 1 percent on all ranges.

- 3000, if 50-Hz line is used.
- 750, if 50-Hz line is used.

2.8 Speed Measurements

2.8.1 Fundamental-Speed Measurement

If the speed of the object being viewed is not known at least approximately, start at a high flashing rate where multiple images result and reduce the flashing rate until a single image is obtained. The first single image occurs when the flashing rate is equal to the rotational speed of the object and the speed can then be read directly from the RPM dial.

IMPORTANT

To determine that a single image has been obtained, the object being viewed must have some identifying mark to provide non-symmetry. For instance, a four-bladed fan must have a mark on one blade only, or a piece of tape can be applied to one tooth of a gear to produce the images shown in Figure 2-3.

On the three lower-speed ranges, a quick check on whether or not the stroboscope is flashing at the fundamental speed of the device being measured can be made by simply switching to the next range without moving the RPM dial. Since the ratio between ranges is approximately 6:1, six images will appear at the next higher range when the stroboscope has been set to the fundamental speed. If only three images appear, for example, the stroboscope has been set to one-half the correct frequency. On the high-speed range, double the speed setting of the RPM dial to check for fundamental-speed operation. A double image will occur when the frequency setting is doubled. If the fundamental speed of the device being measured is above 75,000 rpm, it is not possible to check for the correct speed setting by this method. In this case, refer to paragraph 2.8.3.

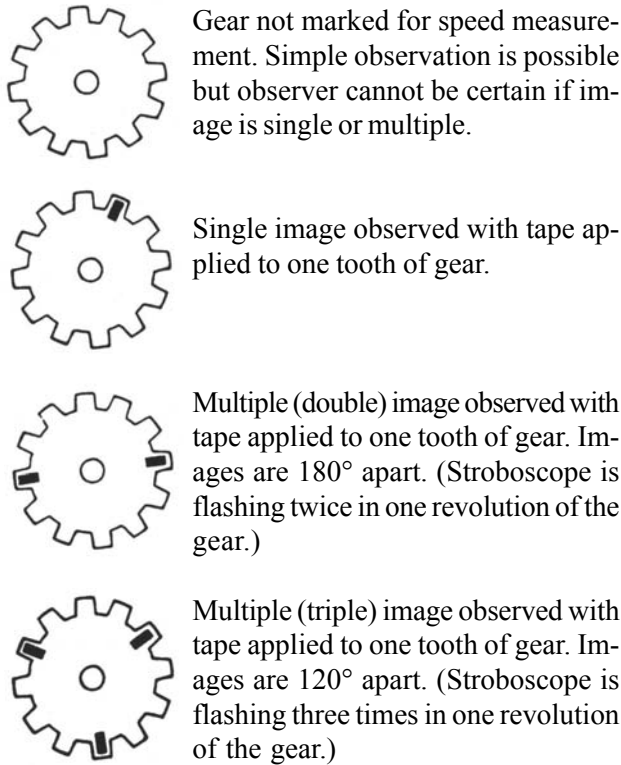

Figure 2-3. Stroboscopic images produced by a rotating gear.

NOTE

Multiple images will always be observed when the flashing rate of the stroboscope is set to a multiple of the fundamental speed of the object. As the flashing rate is reduced from a rate higher than the fundamental speed of the object, the first single image will appear when the flashing rate is equal to the fundamental speed. Make the quick check described above to be sure that the first single image has not been missed.

2.8.2 Submultiple Speed Measurements

When the flashing rate is below the fundamental speed of the object, single and multiple images will be observed. If the stroboscope flashes at an integral submultiple of the speed of the rotating object under observation (such as 1/2, 1/3, 1/4, 1/n), the motion of the object will be "stopped," showing a single image, just as it will at the fundamental speed. If speed measurements are being made, it is necessary to determine whether the stroboscope is flashing at a sub-

multiple rate or at the fundamental rate, as described in paragraph 2.8.1.

Where convenient, switching to a lower range with its submultiple flashing rate (approximately 1/6 of the fundamental frequency) will often prove helpful because of the brighter image obtainable.

Submultiple flashing is necessary to observe or measure the speed of objects moving at rates above 150,000 rpm. Refer to paragraph 2.8.3 for the method of determining the fundamental speed when submultiple operation is necessary.

At flashing rates between integral submultiples, multiple images will be observed. Table 2-1 gives some examples of submultiple speeds and the corresponding number of images produced for a fundamental speed of 180,000 rpm. Note the numerical relationship between the numerator of the submultiple fraction and the number of images. This relationship is true for all submultiple speeds.

Table 2.1

| Relationship between submultiple speed settings and number of images produced for a fundamental speed of 180,000 rpm. | | |
|---|---------------------------|----------------------------------|
| Submultiples of Fundamental Speed (180,000 rpm Assumed) | Number of Images Produced | Reading of Range Switch RPM Dial |
| 1 | 1 | 180,000 |
| 5/6 | 5 | 150,000 |
| 4/5 | 4 | 144,000 |
| 3/4 | 3 | 135,000 |
| 2/3 | 2 | 120,000 |
| 3/5 | 3 | 108,000 |
| 1/2 | 1 | 90,000 |
| 2/5 | 2 | 72,000 |
| 1/3 | 1 | 60,000 |
| 1/4 | 1 | 45,000 |
| 1/5 | 1 | 36,000 |
| 1/6 | 1 | 30,000 |

2.8.3 Measurement of Speeds above 150,000 RPM

By means of submultiple synchronization, speeds up to about 1 million rpm can be measured accurately with the stroboscope. The procedure is as follows:
 a. Starting at 150,000 rpm, decrease the flashing rate

of the stroboscope by turning the RPM dial clockwise until a single image is obtained.

Record the reading of the RPM dial and call it X.

b. Observe the stroboscopic images as the reading of the RPM dial is slowly decreased. Stop when the next single image appears. Record the new reading of the RPM dial and call it Y.

c. Calculate the harmonic number, n , by $n = \frac{Y}{X-Y}$

Round off the value of n to the nearest whole number.

d. Calculate the fundamental speed, S_f , by $S_f = nX$.

For example, if the first single image occurs at $X = 77,200$ rpm and the second single image occurs at $Y = 58,000$ rpm, then

$$n = \frac{58,000}{77,200 - 58,000} = 3.02$$

Rounded off to the nearest whole number, $n = 3$. The fundamental speed is then

$$S_f = 3 \times 77,200 = 231,600 \text{ rpm.}$$

There is a nomogram at the end of this section that may be used for this purpose.

2.8.4 Low-Speed Operation

The measurement of speeds on the low range of the instrument (below about 600 rpm) is complicated by the flicker resulting from the inability of the eye to carry over the image from one flash to the next. Such measurements should be made in a darkened environment to reduce the disconcerting effect of high ambient room lighting on the observed pattern. Dark glasses, worn by the operator, may prove helpful. Speeds below 110 rpm can be measured by means of multiple images. For example, if the flashing rate of the stroboscope is twice the fundamental speed of the device, two images, 180 degrees apart, will appear. At three times the fundamental speed, three images, 120 degrees apart, will appear, etc.

This multiple-image technique can also be used for higher speeds, within the range of the stroboscope, where flicker makes it difficult to tell when the correct flashing rate is obtained (for example, between 110 and 600 rpm).

2.8.5 Slow-Motion Studies

High-speed motion can be reproduced by the stroboscope at an apparently much lower speed if the cyclic or reciprocating motion occurs at a constant rate. If the flashing rate of the stroboscope is set at a speed slightly lower than the fundamental speed of the observed object, the object will appear to move slowly in the same direction as the actual motion, as noted in paragraph 1.2, at a speed equal to the difference between the actual speed of the object and the flashing rate of the stroboscope. If the flashing rate is set slightly higher than the speed of the object being observed, the same slow motion will result, but in the opposite direction.

This stroboscopic technique of slowing down motion can be extremely useful in investigating the operation of a device under normal operating conditions. Excessive vibration, misalignment of parts, mode of vibration of equipment on a shake table, operation of vibrating reeds, actual relation between traveler and thread during a complete revolution of the traveler on a textile spinning frame - these are a few examples of the many slow-motion studies that are possible with the Type 1538.

2.9 Type 1538-P2 Extension Lamp

For use in spaces too small for the complete stroboscope, the Type 1538-P2 Extension Lamp (Figure 2-4) is a convenient accessory. The lamp and reflector in this assembly are identical to those on the Strobotac. The assembly is supplied with a six-foot cord and a plug that mates with the panel socket marked EXT LAMP. When plugged in, the Extension Lamp flashes instead of the lamp on the stroboscope. This accessory makes it possible to mount the lamp in small out-of-the-way places such as test chambers and to control it from a safe distance.

Additional cable up to 50 feet long can be used with the Extension Lamp. The cable and connectors are available from IET Labs, Inc. However, when additional cable is used, the peak intensity of the flash decreases. For instance, with a 25-foot cable, the peak light output is reduced to one fourth of its original value, the flash duration is doubled, and the total light output is reduced to one half.

NOTE

The Type 1538-P2 Extension Lamp and the Type 1538-P4 High-Intensity-Flash Capacitor cannot be used simultaneously.



Figure 2-4. Type 1538-P2 Extension Lamp.

2.10 External Synchronization

2.10.1 Use of the Input Jack

The instrument can be triggered by any electrical signal of at least 1 volt, peak-to-peak, (to a maximum of 10 volts rms) applied at the INPUT jack. For sine-wave inputs, the unit will operate with a 0.35-volt (rms) signal down to 100 Hz. Below this frequency the required amplitude increases to 3.5 volts at 5 Hz. For pulse inputs (i.e., step-wavefront signals), the repetition rate can have any minimum value. The instrument can be synchronized with external signals at frequencies up to at least 150,000 rpm (2.5 kHz). Because a positive-going signal is required at the input to flash the stroboscope, positive pulses are required to synchronize on the leading edge. Negative pulses will result in a delay depending on the trailing-edge characteristics of the input pulse.

To operate the stroboscope from an external electrical signal, set the RPM range switch so that the frequency of the driving signal ($f = \frac{\text{rpm}}{60}$) does not exceed the maximum frequency indicated on the range mask. Set the FLASH CONTROL switch to EXTERNAL.

Connect the external signal to the INPUT jack on the panel; use the standard phone plug supplied. Starting at the fully clockwise position, adjust the RPM dial until satisfactory synchronization is obtained. For large-amplitude inputs there will be a wide range of settings for the RPM dial at which the instrument will operate satisfactorily. For small-amplitude inputs, the range will be correspondingly smaller.

2.10.2 Type 1531-P2 Flash Delay and type 1536 Photoelectric Pick-off

Two very useful accessories for the stroboscope are the Type 1531-P2 Flash Delay and the Type 1536 Photoelectric Pick-off. The combination of these three instruments (Figure 2-5) makes it possible to synchronize the flash of the Type 1538 with the moving object at any desired point in the cycle of operation of the object. These synchronizing devices can operate at very high speeds and do not load the machine under observation.

The Type 1531-P2 Flash Delay is a small, portable, time-delay unit, used to insert a controlled delay period between an externally generated trigger pulse and the resulting light flash from the stroboscope. The flash delay also provides a convenient method of obtaining single-flash photographs at any desired point in the cycle of the moving object.

The Type 1536 Photoelectric Pick-off is used to convert the motion of an object to electrical impulses that can be applied to the stroboscope. It consists of a light source, a simple cylindrical optical system, and a photocell. Variations in reflectivity, produced by the motion of the object being observed, produce electrical signals that are amplified, delayed, and shaped by the Flash Delay, and are then fed to the stroboscope. Power for both the photocell and the lamp are supplied by the Type 1531-P2 Flash Delay.

The reader should refer to the Appendix of this book and to the Operating Instructions for the Type 1531-P2 Flash Delay and the Type 1536 Photoelectric Pick-off for further information concerning these instruments and their use with the Type 1538 Stroboscope.

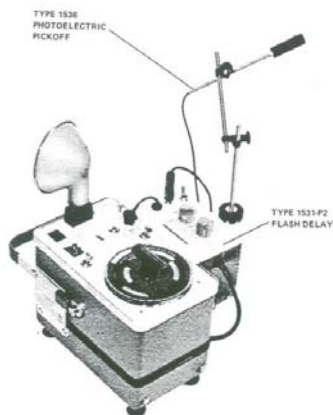

Figure 2-5. A widely used combination consists of the stroboscope with the Type 1531-P2 Flash Delay and the Type 1536 Photoelectric Pick-off.

2.10.3 Type 1537 Photoelectric Pick-off

The Type 1537 Photoelectric Pick-off differs from the Type 1536 in that no light source is included. The photosensitive element is a silicon light-activated switch. This pick-off will trigger the type 1538 Stroboscope directly. Refer to the Instruction Manual for the Type 1537 for further details on the operation of this accessory; its specifications are given in the Appendix of this manual.

2.10.4 Type 1539 Stroboslave

The Type 1539 Stroboslave is an inexpensive, miniature, electronic stroboscope. It has no internal oscillator for setting the flashing rate, and so it must be triggered by an external device. It cannot be used for direct measurement of rotational speed. This small stroboscope is suitable for high-speed-photography applications and motion studies other than tachometry. The Stroboslave will flash upon closure of external contacts or upon reception of a 2-volt positive pulse at its panel INPUT jack. It will operate directly from the OUTPUT jack of the Type 1538 Strobotac. The lamp and reflector of the Stroboslave are connected to the unit by a five-foot flexible cable, to permit positioning the lamp close to the moving object. Operating over a range of 0 to 25,000 flashes per minute, the Type 1539 produces a peak light intensity of up to 11 million beam candles on the HIGH-intensity range and

up to 18 million beam candles when used for single-flash applications. The reader should refer to the Instruction Manual for the Type 1539 Stroboslave. Complete specifications are included in the Appendix of this book.

2.10.5 Use of Multiples Stroboscopes

When a multiple source of flashing light is needed, several Type 1538 stroboscopes can be connected together. A cable from the OUTPUT jack of the first instrument connects to the INPUT jack of another, and so on. Connected in this manner, the stroboscopes will flash at the same time.

Types 1531 and 1546 Strobotac electronic stroboscopes can be substituted for any of the Type 1538 instruments for this multiple use. However, a Type 1531-P4 Trigger Cable (with built-in transformer) must be used at the OUTPUT of each Type 1531 to prevent overload and possible damage to the input circuitry of the 1538 and 1546 units.

2.10.6 Connecting the Accessory Instruments

Figure 2-6 shows the Type 1538 Strobotac electronic stroboscope and the connections for some of the many possible combinations of accessory instruments.

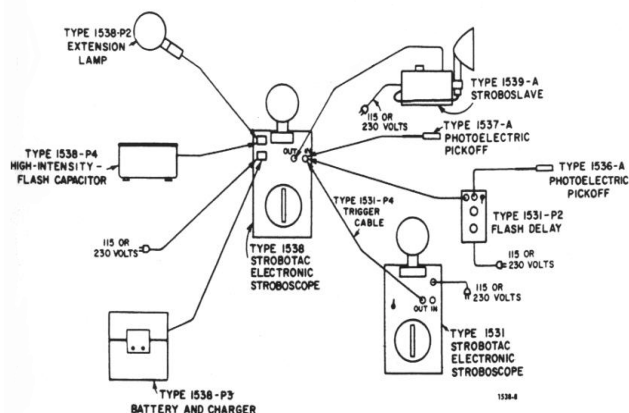

Figure 2-6. Some of the many possible combinations of the Type 1538 Strobotac electronic Stroboscope and its accessory instruments.

2.11 High-Speed Photography

2.11.1 General

The short duration of the flash of light from a stroboscope makes it ideal for high-speed-photography applications. To control the exposure time, the camera shutter can be left open and the light turned on and off very quickly. With the use of convenient controls for triggering, such as a photocell or microphone, the Type 1538 can be used for single flash or can be set to flash at a given rate for multiple exposures. The peak flash intensity of the Strobotac varies with the flashing rate, from about 200,000 candela at the highest flash rate to several million candela at low speeds. When it is desirable, even greater single-flash light intensity (to 44 million candela) can be obtained by addition of the Type 1538-P4 High-Intensity-Flash Capacitor, an optional accessory that plugs directly into the Type 1538 Strobotac (refer to paragraph 2.11.7).

2.11.2 Flash Duration

The duration of the stroboscope flash can vary from 0.5 to 8 microseconds, depending on the flash-rate-range setting (refer to Table 2-2).

Table 2-2

Flash duration at 1/3 peak intensity for each range of the Type 1538 Strobotac.

| RPM Range Switch Setting | Flash Duration (Microseconds) |
|--------------------------|-------------------------------|
| 110-690 | 3 |
| 670-4,170 | 1.2 |
| 4,000-25,000 | 0.8 |
| 24,000-150,000 | 0.5 |

Figure 2-7 shows a plot of light intensity versus duration time. When the Type 1538-P4 High-Intensity-Flash Capacitor is used to produce extra-bright single flashes, duration is increased to 8 microseconds.

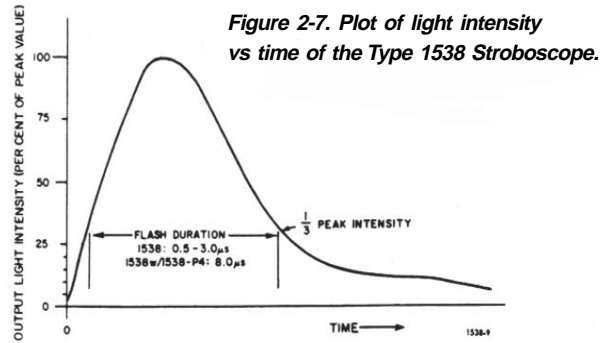

2.11.3 Beam

With the standard reflector in position on the Strobotac, the light output is concentrated in a 10-degree beam (measured at 1/2-peak-intensity points), whose apparent source is 18 inches behind the front of the reflector. Outside this 10-degree cone the light intensity falls off sharply, so that the area of reasonably constant illumination is not large. If this beam width is not adequate to light the subject, the reflector can be easily removed and the bare lamp used to illuminate the area.

2.11.4 Spectral Characteristics

The spectral distribution of the flash of the Strobotac (shown in Figure 2-8) is excellent for photography with both orthochromatic and panchromatic films. Equivalent color temperature of the flash is about 6500 to 7000 degrees Kelvin.

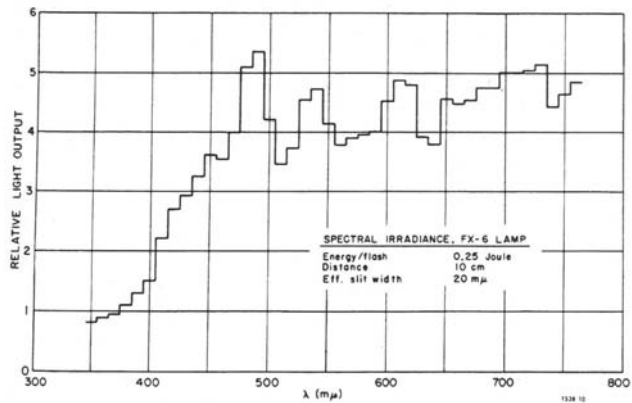

Figure 2-8. Spectral distribution of the Strobotron's light output.

2.11.5 Exposure Data

Figure 2-9 can be used to determine the guide number for a given film speed when the Type 1538 Strobotac or Type 1539 Stroboslave is used. To determine the effective lens aperture (f setting), divide the guide number by the stroboscope-to-subject distance (in feet) plus 1.5 (refer to paragraph 2.11.3).

The guide numbers are given rather than the watt-second ratings, because the latter cannot be used to determine the subject illumination without a full knowledge of the reflector characteristics and the tube efficiency.

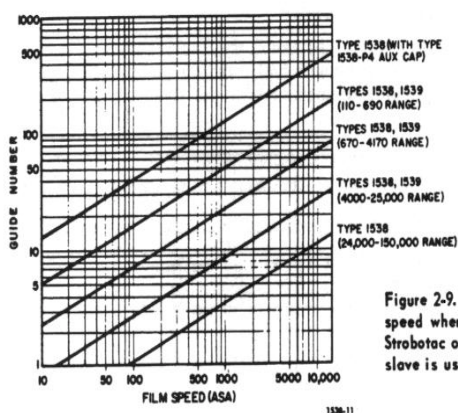

Figure 2-9. Guide number vs film speed when either the Type 1538 Strobotac or the Type 1539 Stroboslave is used.

2.11.6 Single-Flash Photography

With single-flash photography, the camera shutter is opened, the stroboscope is flashed once, to expose the film, and the shutter is closed again. Single-flash pictures, taken in this manner, have solved many puzzling industrial problems. The subject is photographed in the position it occupies at the instant the stroboscope lamp flashes.

NOTE

Because the first trigger pulse from the oscillator is used to charge the flash capacitor, always trigger the stroboscope once or twice before actually taking a single-flash photograph. The capacitor will then be charged, ready to flash the lamp on all subsequent trigger pulses.

2.11.7 Type 1538-P4 High-Intensity-Flash Capacitor

An optional accessory for the Type 1538 Strobotac is the Type 1538-P4 High-Intensity-Flash Capacitor (Figure 2-10). With this accessory connected, a single 8-microsecond flash of 44 million candelas can be obtained.



Figure 2-10. The Type 1538-P4 High-Intensity-Flash Capacitor can be used with the Strobotac for short, single flashes.

This is used when a brighter flash is needed to photograph an object moving at an extremely high speed or one in high ambient light. The circuit for the Type 1538-P4 Capacitor is given in Figure 2-11. To attach the Capacitor to the stroboscope, open the Flip-Tilt cabinet fully, as shown in the lower right-hand view of Figure 1-1. Place the Type 1538 on its side. Attach the Capacitor to the base section of the Flip-Tilt cabinet. To do this, line up the screw in the center of the capacitor with the tripod-mounting hole in the bottom of the Flip-Tilt cabinet. Tighten the screw, locking the capacitor in place. Set the stroboscope upright and plug the cable into the 4-prong socket marked EXT LAMP, on the panel of the stroboscope, as in Figure 2-12. The assembly is now ready for single-flash operation. The maximum flashing rate with the combination is 60 flashes per minute. The Capacitor is automatically discharged when the 4-prong plug in the EXT LAMP socket is removed. The Capacitor can also be discharged by changing the setting of the RPM range switch. Guide numbers for various film speeds when the Capacitor is used with the stroboscope are given in Figure 2-9. The reader should note the instructions in paragraph 2.11.6 for single-flash photography. The Type 1538-P4 High-intensity-Flash Capacitor and the Type 1538-P2 Extension Lamp cannot be used simultaneously with the stroboscope.

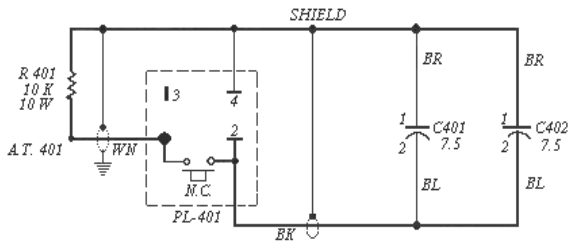
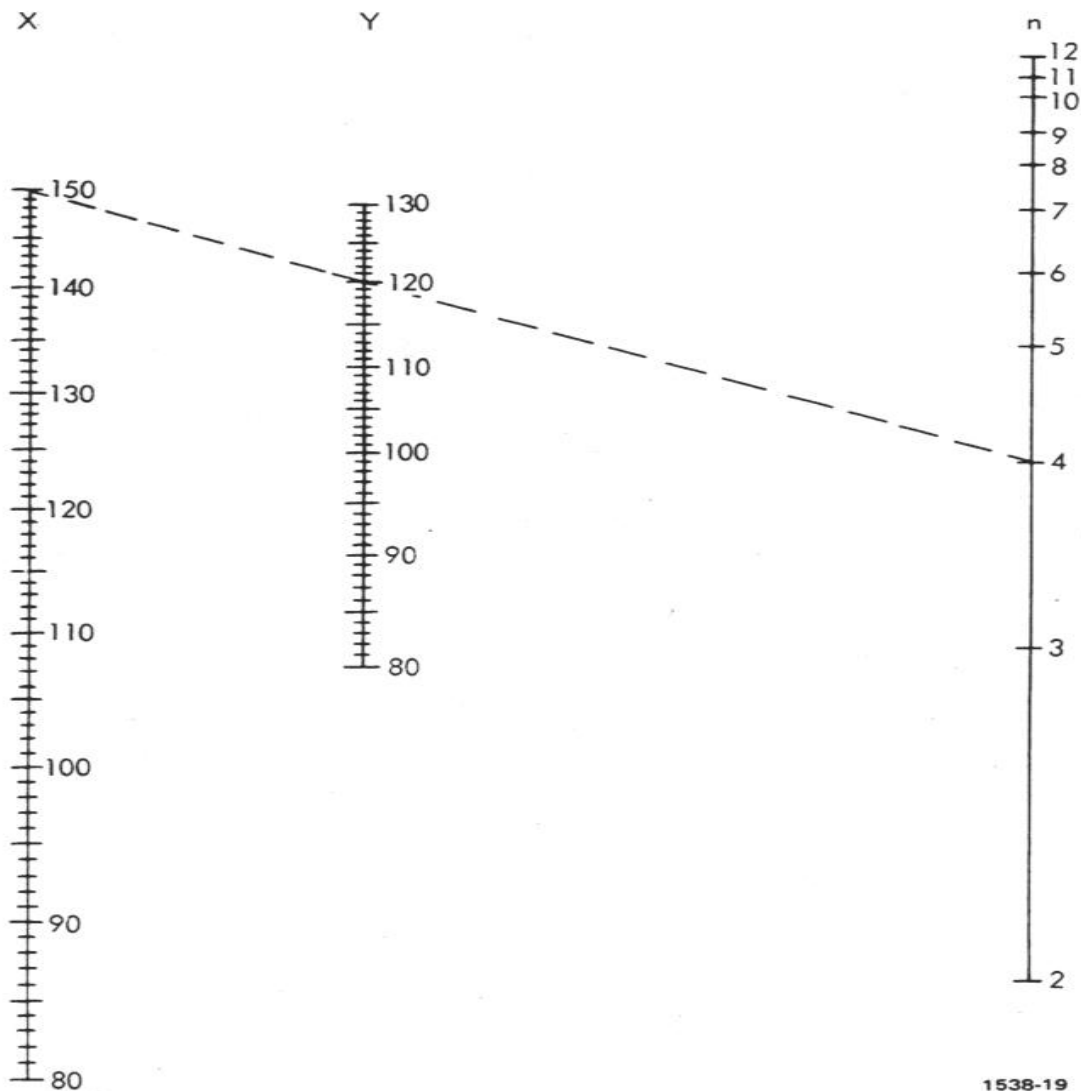

Figure 2-11. Circuit of type 1538-P4 High-Intensity-Flash Capacitor.

NOMOGRAM FOR USE IN MEASURING SPEEDS BEYOND THE FLASHING RATE OF THE TYPE 1538 STROBOTAC

The nomogram below can be used to determine quickly the fundamental speed of an object from two successive submultiple images.



To use the nomogram, find the point on the X scale corresponding to the highest flashing rate at which a true stopped-motion image occurs. Then find the point on the Y scale where the next lower true stopped image occurs. Hold a straightedge so that it intersects the X and Y scales at the points plotted. The straightedge should intersect the n scale at an integer. Multiply the X scale value by this integer to determine the fundamental speed.

Example:

Suppose that the first time stopped-motion image is obtained at 150,000 rpm, the next lower one at 120,000 rpm. A line drawn through 150 on the X scale and 120 on the Y scale intersects the n scale at 4. Therefore the fundamental speed is 4 x 150,000, or 600,000 rpm.

Section 3

PRINCIPLES OF OPERATION

3.1 General

If a cyclically moving object is viewed by a light that is flashing at or near the cyclic rate of the object, the latter will appear stationary or in slow motion. The optical illusion thus produced depends on the periodic observation of the object. If the flashing rate of the light is adjusted to produce a stationary image, the flashing rate equals the cyclic speed of the moving object. The stroboscope is essentially a source of flashing light with an adjustable calibrated control of flash frequency. In most modern stroboscopes the actual flash occurs inside a xenon-filled tube. The gas is ionized by the rapid discharge of a capacitor. The gas must then deionize before the next flash can occur. This deionizing time sets a limit on the maximum flashing rate. If voltage is applied across the tube before the gas is deionized, continuous conduction known as "holdover" occurs.

3.2 The Strobotron Tube

As used in a stroboscope, the strobotron tube contains two main electrodes, a cathode and an anode, separated by 3/8 inch, in an envelope filled with xenon gas at a pressure of one-half atmosphere. A specially designed capacitor acts as a low-impedance source to supply 800 to 1000 volts across these electrodes. The gas, however, remains nonconducting until a 5000-volt pulse is applied to trigger wires interspersed between these main electrodes. This trigger pulse ionizes the gas, and causes up to 1000 amperes to flow through it. This peak flow of almost one million watts generates an intense flash of white light of 15 million beam candles.

After this tremendous pulse of light, the tube requires about 150 microseconds to deionize. The voltage across the tube must remain less than 80 volts during this deionization time or holdover will result.

3.3 The Charging Circuit

The necessary deionization time limits the maximum flashing rate of the stroboscope. Figure 3-1 illustrates the problem. The curves labeled R-C and L-C show the effects of charging the capacitor through a resistor and an inductor, respectively. The slopes required to keep the voltage below the 80-volt deionization level would impose delays in reaching the firing level, which in turn would restrict the maximum flashing rates to 24,000 and 54,000 flashes per minute, respectively, for the particular tube and voltages used in the Type 1538. The answer to this problem is to hold the voltage at zero for the deionization period and then to raise it quickly to the firing level.

The new circuit shown in Figure 3-2 provides an almost ideal charging curve (labeled "Type 1538" in Figure 3-1). During the 150-microsecond deionization time after the strobotron has flashed, the transistor (which acts as a switch) is saturated and the transformer primary current increases, storing energy in the transformer core. The voltage induced in the secondary winding during this buildup is blocked by the diode rectifier, and no voltage appears across the capacitor and strobotron tube. At the end of this 150-microsecond interval, the transistor is switched off, and the primary current goes to zero. The collapsing magnetic field generates a reverse-polarity voltage in the secondary, causing the diode to conduct and the stored energy to be transferred to the capacitor.

When the energy in the transformer is zero, the current again reverses and the diode appears as an open circuit, leaving all the stored energy in the capacitor. This transfer can be made as fast as one wishes, and the flashing rate can therefore be made to approach the theoretical maximum.

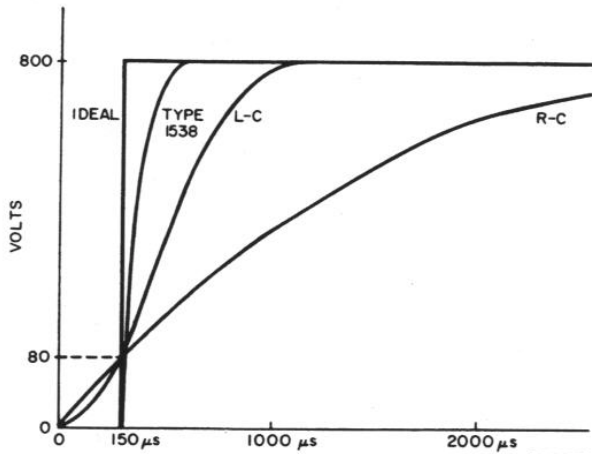

Figure 3-1. Voltage-vs-time characteristics of various charging circuits.

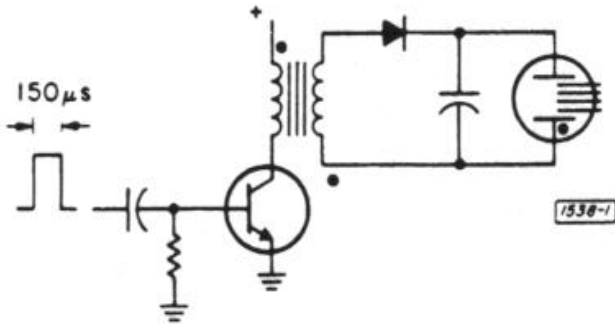

Figure 3-2. Charging circuit of the Type 1538 Strobotac electronic stroboscope.

The transfer of energy from the power supply to the intermediate storage inductor, and then resonantly to the discharge capacitor, can be made with an efficiency approaching 100%. In the conventional RC charging circuit, however, half of the available energy is dissipated in the charging resistor regardless of the value of the resistor (including zero ohms). The use of inductive charging saves the power ordinarily dissipated in the charging resistor and reduces power requirements, so that battery operation is practical.

Moreover, the use of a transformer as the inductive element permits the use of a low-voltage transistor circuit to generate the high voltage required by the strobotron tube. A block diagram of the complete circuit is shown in Figure 3-3. A transistorized RC oscillator sets the flashing rate of the stroboscope. Once each cycle, a transistor trigger circuit generates a 5-kilovolt, 5- μ s pulse to trigger the strobotron tube. In the time between these pulses, the main discharge capacitor (which varies from 0.007 μ F on the high range to 1.5 μ F on the low range) must be recharged to 800 volts. The monostable circuit, triggered by the oscillator, generates a 200- μ s pulse that saturates the transistor switch, stores energy in the transformer, and allows the strobotron to deionize. At the end of the 200- μ s pulse, sufficient energy has been stored to resonantly charge the capacitor to 800 volts in an additional 200 μ s. Thus, a maximum flashing rate of $\frac{1}{400}$ μ s or 2500 flashes per second is possible.

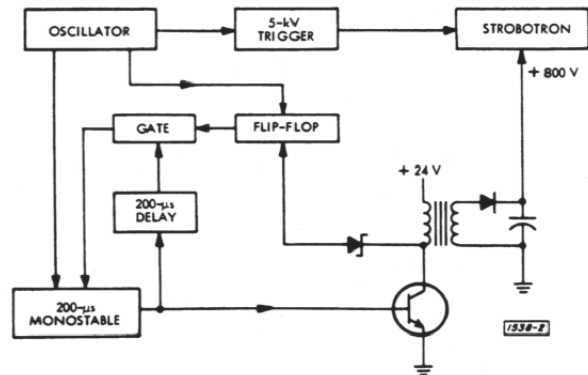

Figure 3-3. Block diagram of the Type 1538 Strobotac electronic stroboscope.

The average light output of a stroboscope varies directly with flashing rate and discharge capacitance. The exceptionally wide flashing-rate range of the Type 1538 (1500 to 1) would mean a drastic variation in light output if only one discharge capacitor were used. On the other hand, a continuously adjustable discharge capacitor with a 1500-to-1 range was obviously impractical. The compromise solution was to switch in a different capacitor for each of the four 6:1 speed ranges. The resulting capacitance variation is 216 to 1, and this raises another design problem.

If the discharge capacitor varies in value over a 216-to-1 range, then, in the resonant charging circuit discussed earlier, either the inductance must also vary by a factor of 216 or the current must vary by a factor of 216 to supply sufficient energy per cycle. Large coils and 30 A current were both unappealing, so another approach was found.

On lower-speed ranges, however, where the discharge capacitance is higher, the energy stored in the transformer is insufficient to produce the desired 800-volt firing potential. On these ranges, the 200- μ s delay following the monostable circuit generates a trigger pulse occurring 200 μ s after the end of the monostable pulse, to retrigger the monostable circuit. Thus a single pulse from the oscillator starts a train of 200- μ s pulses in the monostable circuit and its delay loop. Each of these pulses stores energy in the inductor that is repeatedly transferred to the capacitor during the time between pulses. Each pulse raises the capacitor voltage in a small step, as shown in Figure 3-4. This process continues until the capacitor is charged to 800 volts. At each step, a voltage pulse equal to the capacitor voltage divided by the transformer turns ratio appears across the Zener diode on the transformer primary. When the capacitor reaches 800 volts, the diode voltage is exceeded and the flip-flop closes the gate. This breaks the feedback loop and ends the pulse train started by the oscillator. While this multiple-cycle resonant-charging technique used on the lower ranges requires more time than the single-cycle charge, a correspondingly longer time is available in which to recharge the capacitor.

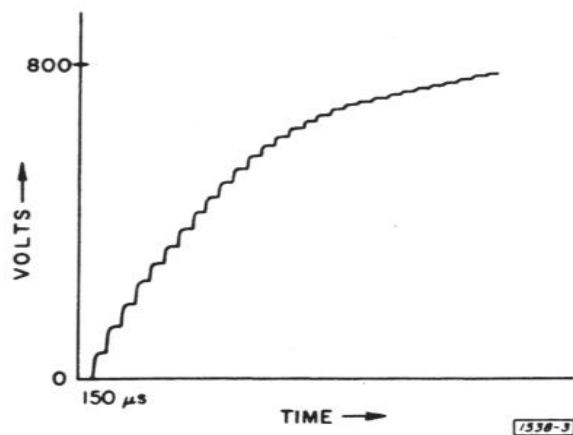

Figure 3-4. The voltage buildup on the charging capacitor is in small steps.

3.4 The Calibration Circuit

To calibrate the RPM dial against the power-line frequency, voltages at both the power-line and the flashing-rate frequencies are superimposed across a neon lamp (V901). When the flashing rate equals the power-line frequency or a submultiple of it, the voltage across the lamp remains constant and the lamp is in a condition of steady intensity. Depending upon the phase relationship between the strobotron flashing rate and the power-line frequency, the steady-intensity condition of the neon lamp may be maximum intensity or zero intensity. If the flashing rate of the strobotron differs from the power-line frequency, the average voltage across the neon lamp will vary, and the intensity will change at the difference frequency.

Section 4

SERVICE AND MAINTENANCE



Dangerous voltages are present inside the case of this instrument. For safety, do not remove instrument from its case. Refer all servicing to qualified personnel.

4.1 Customer Service

The IET warranty attests to the quality of materials and workmanship in our products. For application assistance or if difficulties occur, our engineers will assist in any way possible. If you cannot eliminate the difficulty, please e-mail, FAX, or phone our Service Department, giving full information of the trouble and of steps taken to remedy it. Be sure to include the type and serial number of the instrument.

In the U. S. call
800-475-1220 or 617-969-0804 for technical support
800-899-8438 or 516-334-5959 for customer service
516-334-5988 for FAX
www.ietlabs.com

4.2 Instrument Return

Before returning an instrument to IET for service please call our Service Department at 800-899-8438 for Return Material Authorization (RMA). Include a Purchase Order Number to insure expedient processing. Units under warranty will be repaired at no charge. For any questions on repair costs or shipment instructions, please contact our Service Department at the above number. To safeguard an instrument during shipment, please use packaging that is adequate to protect it from damage, (i.e., equivalent to the original packaging) and mark the box "Delicate Electronic Instrument".

Return material should be sent freight prepaid to:

IET Labs, Inc.
10 Dedham Street
Newton, MA 02461

Attention: Service Department

4.3 Minimum Performance Standards

4.3.1 General

The following procedures are recommended for incoming inspection or periodic checks of the instrument. Complete instructions for the calibration of the stroboscope are given in paragraph 2.7.

4.3.2 Equipment Required

| | |
|---|---------------------------------------|
| 1 | Audio Oscillator, 20 Hz @1 Vrms |
| 1 | Frequency Counter Range: 1-2500 Hz |
| 1 | Digital Multimeter |
| 1 | General-Purpose Oscilloscope |

4.3.3 Preliminary Check

With the power connected, turn on the POWER switch. There must be no erratic action of the flash tube on any of the four speed ranges.

4.3.4 Flashing-Rate Accuracy Check

Connect the OUTPUT jack of the Type 1538 to the INPUT of the frequency counter. After calibration according to the instructions of paragraph 2.7, all speeds on all ranges of the stroboscope must check within $\pm 1\%$ of the dial reading.

$$\text{NOTE: Hz} = \frac{\text{RPM}}{60}$$

4.3.5 Input Check

Set the FLASH CONTROL to EXTERNAL, the range switch to 110-690 RPM, and the knurled dial fully clockwise. The tube must flash each time the INPUT terminals are shorted. (It will not fire at the first short if the capacitors are not charged, but will fire with the second and all succeeding shorts.)

Apply 1 volt rms at 20 Hz from the audio oscillator to the INPUT jack of the stroboscope. It must be possible to flash the tube at some position of the speed control (knurled dial).

4.3.6 Output Check

Set the FLASH CONTROL to INTERNAL and the range switch to 24000-150000 RPM. With the oscilloscope, measure the voltage at the OUTPUT jack; it must be a positive pulse >6 V in amplitude.

4.4 Maintenance

4.4.1 Case Will Not Lock Properly

If the screws that fasten the side plates of the handle assembly to the cover become loose, proper operation of the slide pins may become difficult or impossible. Close the instrument and set the slide pins in the locked position by moving the side plates up or down. Tighten the screws on the plates. Check the operation in the open position. If necessary, loosen the side-plate screws and reposition the plate slightly, so the case will lock in both opened and closed positions.

4.4.2 Cleaning the Reflector

If it becomes necessary to clean the inside of the reflector, pull it free of the swivel assembly. Wipe the reflecting surface carefully with a soft, lint-free cloth. If necessary, moisten the cloth with water. Do not use solvents of any kind, as they may damage the surface.

4.4.3 Removing the Instrument from its Case



Before removing the instrument from its case, turn OFF the POWER switch and rotate the RPM range switch at least one position in either direction, to discharge the capacitor and prevent exposure to 800 volts.

To remove the instrument, open the case and place the instrument with the panel in a vertical position. Remove the four screws from the bottom of the case, (side opposite the panel) and pull the instrument forward, out of the case.

4.4.4 Replacing the Fuse

To replace the fuse, remove the instrument from the case as described in paragraph 4.4.3. Remove screws A and B only (Figure 4-1), in the large, power-supply, etched board (P/N 1538-2751, Figure 4-11) and swing the board away from the panel, as shown in Figure 4-2. Do not allow the board to swing free, or it may be damaged. The 0.25-ampere fuse (F901, Figure 4-2) is now readily accessible, in its mounting on the back of the panel.

4.4.5 Replacing the Strobotron Lamp



The Strobotron lamp may develop an internal coating after many years of operating; if its efficiency becomes unsatisfactory, it should be replaced. It will rarely cease to operate completely.

Avoid touching the Strobotron pins when removing the lamp. With the power to the instrument turned ON, 800 volts is present at the pins. Also, the tem-

perature of the lamp may be quite high if the instrument has been operating for some time.

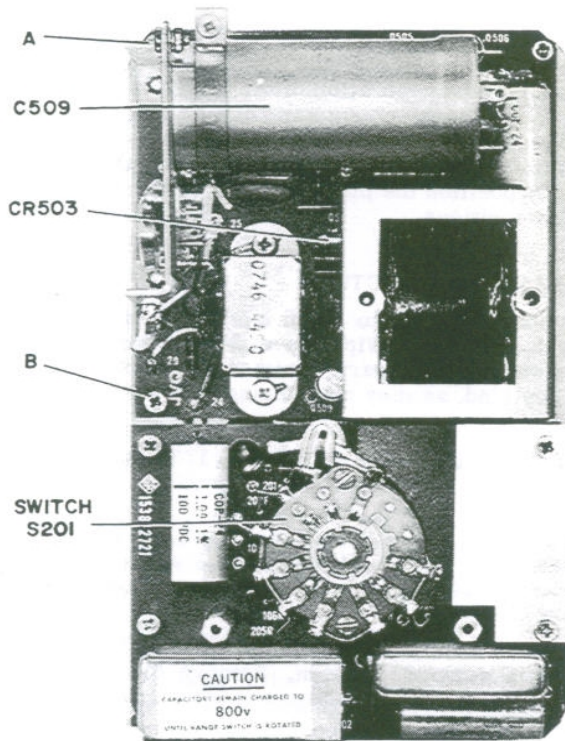

Figure 4-1. The power-supply etched-circuit board is pivoted to swing out when screws A and B are removed.

To replace the strobotron lamp, first pull the reflector from the swivel assembly. Move the lamp slightly from side to side until it is free of the socket. Be sure the leads on the replacement lamp are not bent, and that, after it is inserted, the lamp is fully seated in the socket.

4.4.6 Replacing the Dial Lamp

To replace the dial lamp, remove the instrument from the case (refer to paragraph 4.4.3). Remove screws A and B only (Figure 4-1), in the large, power-supply, etched board (P/N 1538-2751) and swing the board away from the panel, (see Figure 4-2). The dial lamp is now readily accessible, as shown in the figure.

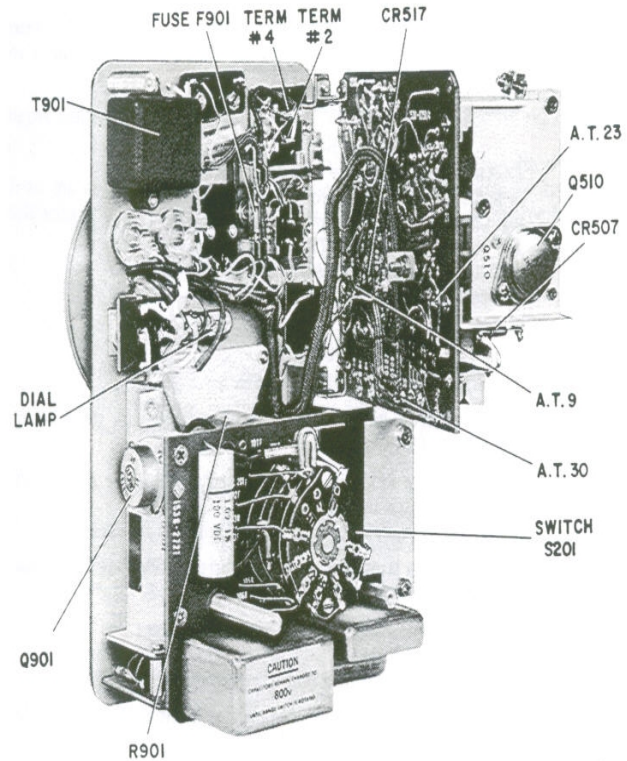

Figure 4-2. The power-supply board swung out to expose the under side, the fuse, and the dial lamp.

4.4.7 Repositioning the RPM Dial and Knob

The RPM dial should not move when the RPM range switch knob is turned. If it does, the mask is rubbing on the dial. To correct this, loosen the two setscrews in the knob, slide knob and mask forward slightly (away from the panel) and again tighten both setscrews.

4.4.8 Converting to the other Power-Line Voltage

A change in line voltage from 115 volts, to 230 volts, or vice versa, requires a change in position of the jumpers on the terminals of transformer T501. Also, the markings above the front-panel power socket should be changed to indicate the new power ratings. These changes are described in detail in paragraph 2.3.1. The 0.25-ampere fuse (F901) is used for either voltage.

4.5 Trouble Analysis

NOTE

Except where otherwise noted, the trouble-shooting procedures described below are based on the following initial conditions: Unit is operating on AC power; FLASH CONTROL switch is set to INTERNAL; No accessories are attached to the stroboscope.

4.5.1 Strobotron Lamp does not Flash

a. If the strobotron lamp (V-902) does not flash with the FLASH CONTROL switch at INTERNAL:

1. Be sure the RPM range switch is not at CAL; the strobotron will not flash with the switch in this position.
2. Be sure the strobotron is seated firmly in its socket.

b. If the strobotron lamp does not flash and the RPM dial lamp does not light:

1. Make certain that the input power is correct.
2. Check fuse F901.
3. If a replacement fuse blows, remove transistor Q510. Should the fuse no longer blow, the trouble may be in either Q510 or diode CR503. Replace the faulty component.
4. If the fuse continues to blow with transistor Q510 removed, the trouble is in the power supply. Check for -24 volts at A.T.9. Also check the power-supply components.
5. Be sure the dial lamp is not faulty.

c. If the strobotron lamp does not flash but the dial lamp lights:

1. Try all positions of the RPM range switch. If strobotron flashes on the 24000 - 150000 RPM range only, change the range switch to the 4000 - 25000 range, and momentarily place a jumper from the collector to the emitter of transistor Q107. If the strobotron flashes, the trouble is in the flip-flop circuit (Q107 or Q108). Should the strobotron not flash properly, the feedback gate (Q104, Q105, Q106) is malfunctioning.
2. If the strobotron does not flash on any position of the RPM range switch, repeat the procedure of paragraph 4.5.1, b. If the voltage at A.T.9 is correct, set the switch to the 24000 - 150000 range and, in a darkened room, look closely for very low-intensity arcing between the electrode tips of the strobotron lamp. Should the arcing be absent, check for 800 volts; dc,

at pin #4 of the strobotron socket with the lamp removed (heed warning of paragraph 4.4.5). If the arcing is not visible (or the voltage is not correct), plug a Type 1538-P2 Extension Lamp into the EXT LAMP socket on the front panel. If that lamp flashes, the trouble may be in switch S903 or in the original strobotron lamp,

(a) To check the switch, apply external pressure to the upper contact arm to close the contacts, or connect a jumper between them.

(b) Replace the lamp in the stroboscope with a known good lamp. Should that lamp not flash, be sure the following voltages are correct (see the schematic diagram, Figure 4-14):

-24 volts at A.T.9

-15 volts at A.T.30

CAUTION

Use extreme care when measuring the -15 volts. Even a momentary short may destroy transistors Q507, Q508, or Q509, or diode CR517.

(c) If both voltages are low, remove transistor Q510 from its socket (see Figure 4-3) and recheck the voltages. If they are now correct, transistor Q510 or Q501 or diode CR503 is faulty. If the voltages remain incorrect, check the low-voltage power supply. If only the voltage at A.T.30 is incorrect, the trouble is in the -15 V regulator circuit.

(d) If the voltages are correct at A.T.9 and A.T.30, continue with the following procedure:

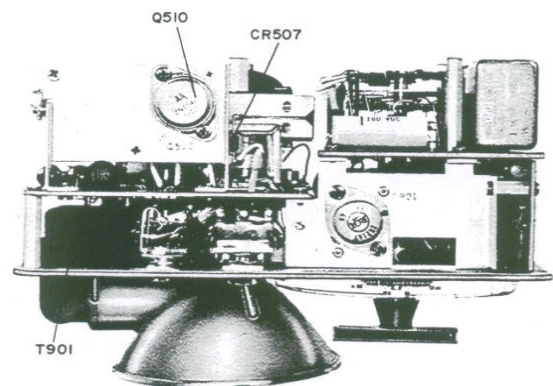

Figure 4-3. Right-side interior view of the Stroboscope.

- (1) Set the RPM range switch to CAL and the dial to 3800 RPM. The CALIBRATE lamp should now operate with a pulsating glow. If it does, the trouble must be in the trigger generator (transistors Q505, Q506, Q901).
- (2) If the CALIBRATE lamp is not operating, check the waveform at the panel OUTPUT jack (see Figure 4-4) or set the RPM controls to 150000 RPM and determine that some voltage is present at the jack; use a high-impedance meter on the $\sim 3\text{Vac}$ range. Correct waveform or voltage indicates trouble in the trigger generator (Q505, Q506, or Q901); an incorrect result indicates trouble in the oscillator section, Q101, Q102, Q103.
3. (a) If the low-intensity arcing is visible between the electrodes of the strobotron, as described in step c, 2, above, check the strobotron lamp by replacing it with one known to be good.
 - (b) If the trouble persists, set the RPM range switch to CAL, the dial to 3800, and check that the CALIBRATE lamp is operating with a pulsating glow.
 - (c) If the CALIBRATE lamp is not operating (with a pulsating glow, step (b), above), check for proper waveform at the OUTPUT jack (see Figure 4-4); or set the RPM controls to 150,000 RPM and determine that some voltage exists at the OUTPUT jack. Incorrect waveform or voltage indicates that the oscillator circuit (Q101, 102, 103) is not functioning properly.

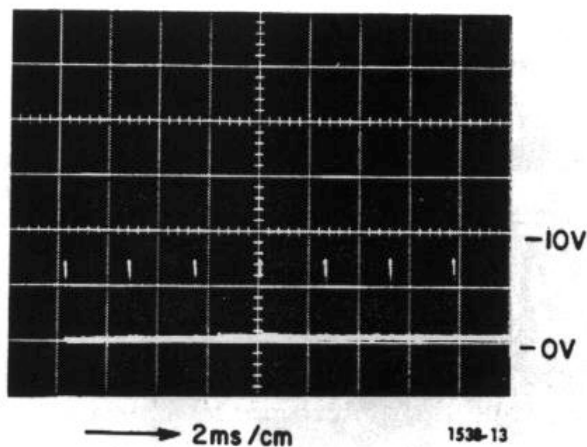

Figure 4-4. Voltage waveform at the panel OUTPUT jack (24,000 RPM).

- (d) If the CAL lamp is operating properly, turn off the POWER switch and carefully remove the strobotron from its socket (heed the warning of paragraph 4.3.5). Set the RPM range switch to the 110-690 range. Measure the voltage between pins #4 and #9 of the socket; it should be at least 700 volts, dc. Improper voltage indicates a defective diode CR507 or faulty wiring. Also check diode CR503 and transistor Q510 (as in step c, 2, (b) and (c), above). (e) With the correct waveform or voltage in step (c), above, measure the voltages at A.T.9 and A.T.30. Follow the instructions in steps c, 2, (c) and (d). (f) With the correct voltages at A.T.9 and A.T.30, observe the waveform at A.T.65 (see Figure 4-5). If it is incorrect, the trouble is in the 200 μsec monostable circuit.

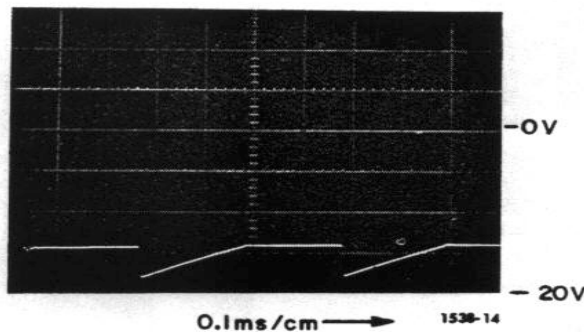

Figure 4-5. Voltage waveform at A.T.65 (24,000 RPM).

4.5.2 Strobotron Lamp Flashes Erratically

- a. Set the FLASH CONTROL switch at EXTERNAL. Rotate the RPM dial counterclockwise through its entire range. Only a single flash should be observed. More than one indicates a noisy potentiometer R901.
- b. Check the strobotron lamp by substituting one known to be good.
- c. Observe the waveform at the OUTPUT jack (see Figure 4-4). Unevenly spaced pulses indicate erratic operation of the oscillator section.
- d. Observe the waveform at pin #3 of the panel EXT LAMP socket (S0901) and compare it with that of Figure 4-6. Improper waveform is caused by trouble in the trigger generator.

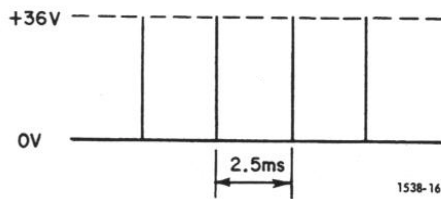

Figure 4-6. Voltage waveform at pin #3 of the panel EXT LAMP socket, S0901 (24,000 RPM).

e. Compare the waveform at A.T.23 with that given in Figure 4-7. An incorrect waveform indicates a faulty 800-volt supply. Check CR504, Q510, CR503, and CR507. (NOTE: Transistor Q510 may break down due to high-voltage pulses.)

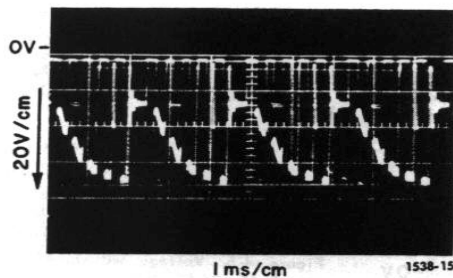

Figure 4-7. Voltage waveform at A.T.23 (24,000 RPM).

f. Compare the waveforms at A.T.65 and A.T.63 with those given in Figures 4-5 and 4-8, respectively. Improper waveforms indicate trouble in the flip-flop circuit (Q107 and Q108).

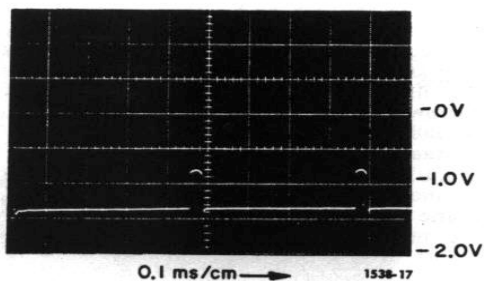

Figure 4-8. Voltage waveform at A.T.63 (24,000 RPM).

4.5.3 Improper Operation with External Input

a. Change the FLASH CONTROL switch to INTERNAL and check for normal operation. If trouble exists on the INTERNAL position also, refer to paragraph 4.5.1 and follow the procedure that applies.

b. If normal operation is noted on INTERNAL, return the switch to EXTERNAL and turn the RPM dial to the last 90 degrees of its clockwise rotation.
 c. If trouble continues, be sure the external trigger is adequate (refer to the Specifications). Also, start with the RPM dial fully clockwise, and turn it counterclockwise about 90°, to increase the input sensitivity to the trigger point; a single flash should occur.

4.5.4 Improper Operation with Battery Power

a. If the RPM dial lamp lights, the trouble is in the stroboscope, not in the battery. Try operation on the ac line; refer to the appropriate symptom in paragraph 4.5.1.

b. If the RPM dial lamp does not light, check the battery fuse, F302. If the fuse has blown, replace it. If a replacement fuse blows, refer to paragraph 4.5.1, step b.

c. Turn the stroboscope ON and check the battery voltage at socket S0303. Recharge the battery if the voltage is below 20 volts.

d. If the battery does not recharge, the battery may need replacement, or the charger may need service. Please contact IET for instructions.

4.5.5 Type 1538-P2 External Lamp does not Flash; Front-Panel Strobotron Lamp Flashes

a. Test the external lamp by substituting one known to be good.

b. Set the RPM range switch to 24000 - 150000. Inspect the external strobotron lamp for low-voltage trigger flashes between the electrodes (refer to paragraph 4.5.1 step c, 2). If the flashes are not visible (in a darkened room), or if the voltage between pins #4 and #9 of the external lamp socket is not approximately 800 volts, dc, then the external lamp assembly is defective. Check for 800 volts dc between terminals #2 and #4 of the panel EXT LAMP socket.

c. Compare the waveform at terminal #3 of the panel EXT LAMP socket with the waveform shown in Figure 4-6. A discrepancy in the waveform indicates a broken wire associated with the EXT LAMP socket, or malfunctioning of switch S903.

d. If the cause of the trouble cannot be determined by the above procedures, return the complete Type 1538-P2 External Lamp to IET Labs, Inc.

4.6 Replacement of Mechanical Parts

4.6.1 General

Although the stroboscope is designed especially for use in manufacturing, testing, and other areas where the working environment is often unsuitable for precision electronic instruments, certain mechanical parts mounted on the outside of the instrument case may eventually become contaminated or damaged. To replace these parts (see Figure 4-9), refer to the following instructions.

4.6.2 Reflector and Cover

Remove the old reflector by pulling it off the swivel-support assembly. Mount the new reflector by sliding it onto the assembly until the spring-loaded detent button snaps into the groove inside the reflector base. To replace the reflector cover, remove the old cover by pushing on the edge at each of the molded-in clips that clamp over the rim of the reflector housing; the cover will snap off. Then mount the new cover by pulling its edge toward the rim of the reflector housing until the three clips snap securely into place.

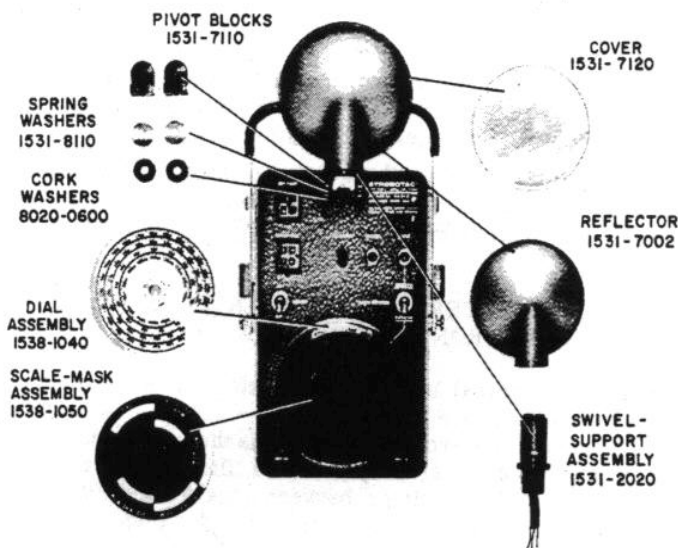

Figure 4-9. Miscellaneous part numbers.

4.6.3 Swivel-Support Assembly, Pivot Blocks, and Washers

To replace the swivel-support assembly (see Figure 4-10):

- Remove the reflector and the strobotron lamp; then remove the instrument from its case.
- Loosen (do not remove) two nuts (A, Figure 4-10) and slide the two pivot blocks apart. (The heads of the two screws (B) clamp the pivot blocks in position when nuts (A) are tightened.)
- Unsolder the three swivel-support assembly leads (X, Y, Z) and remove the assembly.
- The pivot blocks and washers can now be replaced.
- Position the new swivel-support assembly so that the strobotron tube socket and leads (X, Y, Z) are as shown in the figure.
- Insert leads (X, Y, Z) through the slot between screws (B), and hold the swivel-support assembly in position between the two pivot blocks.
- Slide the pivot blocks together and tighten nuts (A). The pivot action of the swivel-support assembly may need readjustment; if so, loosen either nut (A), adjust the corresponding pivot block, and retighten the unit.
- Solder leads (X, Y, Z) to the terminals, as shown.

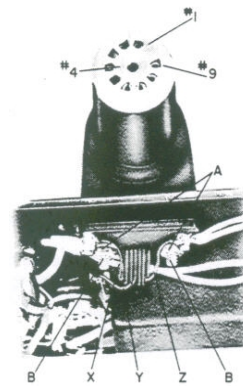

Figure 4-10. Interior view showing mounting of the swivel-support assembly, pivot blocks, and connections.

4.6.4 Scale Mask Assembly

To replace the Scale Mask Assembly:

- Set the range switch to the 4000-25000 RPM position.
- Loosen the two setscrews in the Scale Mask Assembly hub and remove the assembly from the range-switch shaft.
- Mount the new Scale Mask Assembly on the shaft and center the 4000-25000 RPM window in the dial over the white panel segment beneath the dial.
- Tighten both setscrews securely.

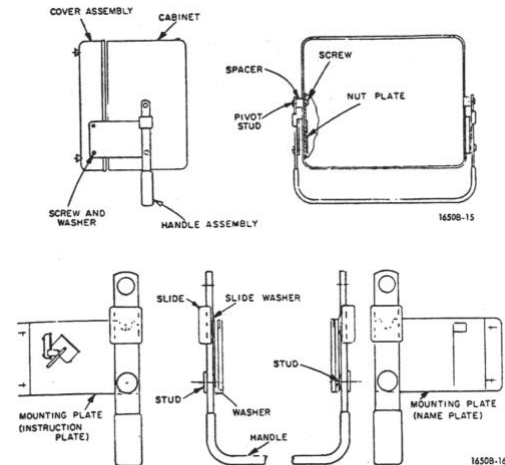

Figure 4-11. Name and location of parts included in the IET Flip-Tilt Case (refer to table 4-1).

4.6.5 Dial

To replace the Dial:

- Remove the instrument from the case. Heed the warning of paragraph 4.4.3 (to prevent contact with 800 volts).
- Set the range switch to the 4000-25000 RPM position and remove the Scale Mask Assembly (refer to paragraph 4.6.4, steps a and b).
- Note the approximate dial setting and remove the dial from the potentiometer shaft without turning the shaft. To remove the dial, loosen the two setscrews in the dial hub, under the instrument panel.
- Mount the new dial at the approximate setting noted in step c, Tighten one setscrew in the dial hub.

CAUTION

The dial should not rub against the panel when rotated; allow a minimum clearance of 1/16 inch.

- Rotate the dial from the limit stop in one direction to the limit stop in the other direction. Note the distance between the red marker and each end of the 4000-25000 RPM scale. (The ends of the scale should travel approximately 1/4 inch beyond the red marker.) Adjust the dial until the red marker is equidistant from each end of the scale.
- Tighten both setscrews in the dial hub.
- Mount the Scale Mask Assembly (paragraph 4.6.4, steps c and d) and remount the instrument in the case.
- Calibrate the stroboscope before making speed measurements.

Table 4-1

| Part numbers for the flip-tilt case | |
|-------------------------------------|--------------|
| Name | IET Part No. |
| Cabinet | 1538-1080 |
| Spacer | 4170-0900 |
| Pivot Stud | 4170-1267 |
| Screw | 7080-0800 |
| Handle Assembly | 1538-2040 |
| Cover Assembly | 1538-2049 |
| Screw | 7080-0800 |
| Washer | 8050-1500 |
| Mounting Plate (Inst. Plate) | 7860-1880 |
| Stud | 4170-1200 |
| Slide | 4170-1271 |
| Handle | 5360-5881 |
| Mounting Plate (Nameplate) | 7864-8010 |
| Washer | 8140-0102 |
| Slide Washer | 4170-7030 |

NOTE: Tighten 10-32 screws to 20-25 in. lbs torque. Bend mounting plate to give 1/32 to 1/16 spacing, both sides.

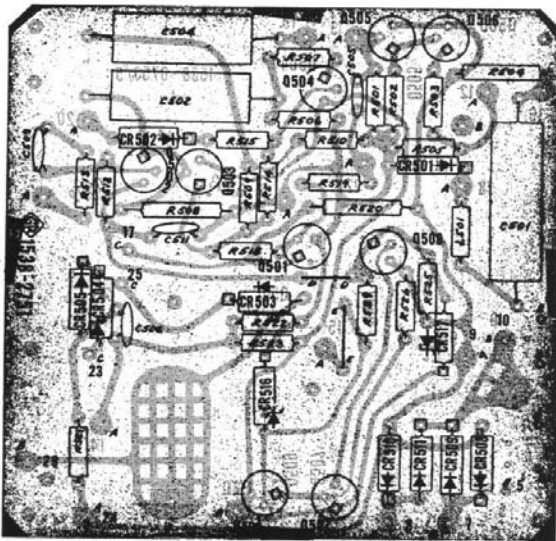

Figure 4-12. Power supply etched-board assembly. (Complete assembly is P/N 1538-2751).

NOTE: The number appearing on the foil side is not the part number. The dot on the foil at the transistor socket indicates the collector lead.

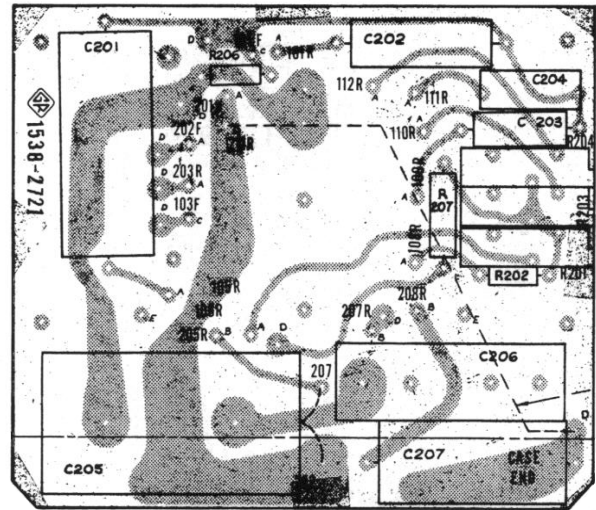

Figure 4-14. Switch-circuit etched-board assembly. (Complete assembly is P/N 1538-2721.)

NOTE: The number appearing on the foil side is not the part number. The dot on the foil at the transistor socket indicates the collector lead.

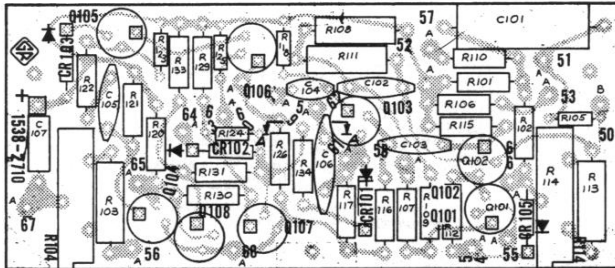

Figure 4-13. Oscillator etched-board assembly. (Complete assembly in P/N 1538-2710.)

ELECTRICAL PARTS LIST

| CHASSIS MOUNTED PARTS | | P/N 1538-3000 | | |
|-----------------------|-----------------------------------|---------------|-------|-------------------|
| REFDES | DESCRIPTION | PART NO. | FMC | MFGR PART NO. |
| C 901 | CAPACITOR | 1538-0440 | 24655 | 1538-0440 |
| F 901 | FUSE SLC-BLCK 1/4A 250V | 5330-0700 | 75915 | 313 -250 |
| J 901 | PHONE GNC .281L 2 CK T | 4260-1030 | 82389 | 111 |
| J 902 | PHONE GNC .281L 2 CK T | 4260-1030 | 82389 | 111 |
| P 901 | LAMP BAYONET BASE 28V .04A | 560C-1000 | 24455 | 1819 |
| PL 901 | RECPT JCNES 4 CCNT MALE | 4220-4400 | 71785 | P-004-AB |
| Q 901 | TRANSISTOR 2N4906 | 8210-1172 | 04713 | 2N4906 |
| R 902 | RES COMP 4.3 K OHM 5PCT 1/2W | 6100-2435 | 81349 | RCR20G432J |
| S 901 | SWITCH TOGGLE 2PCS DPCT STEADY | 7910-1500 | 04009 | 83054 |
| S 902 | SWITCH TOGGLE 2PCS DPST STEADY | 7910-1300 | 04009 | 83053 |
| S 903 | SWITCH ASM | 1536-3070 | 24655 | 1538-3070 |
| SO 901 | SOCKET MULTIPLE | 1536-8090 | 24655 | 1538-8090 |
| T 901 | TRANSFORMER ASM | 1538-2000 | 24655 | 1538-2000 |
| V 901 | LAMP NEON NE-2L | 8390-0310 | 24455 | 3AD |
| V 902 | 1539-P1 REPLACEMENT FLASH LAMP | 1538-9601 | 24655 | 1538-9601 |
| OSCILLATOR PC BOARD | | P/N 1538-2710 | | |
| C 101 | CAP MYLAR .1UF 10 PCT 100 V | 4860-8250 | 56289 | 410P 0.1 UF 10PCT |
| C 102 | CAP CER DISC 2200PF 10PCT 500V | 4406-2228 | 72982 | 0871082Z5D00222J |
| C 103 | CAP CER DISC.01UF 80/20PCT 500V | 4406-3109 | 72982 | 0811082Z5U00103Z |
| C 104 | CAP CER DISC 390PF SPCT 500V | 4404-1395 | 72982 | 0831082Z5D00391J |
| C 105 | CAP CER DISC 2200PF 10PCT 500V | 4406-2228 | 72962 | 0871082Z5D00222J |
| C 106 | CAP CER DISC.022 UF 80/20PCT 500V | 4407-3229 | 72982 | 0841087Z5U00223Z |
| C 107 | CAP TANT 1.0 UF 20PCT 35V | 4450-4300 | 56289 | 150D105X0035A2 |
| CR 101 | DIODE 1N4154 25PIV IR .1UA SI | 6082-1012 | 14433 | 1N4154 |
| CR 102 | DIODE 1N4154 25PIV IR .1UA SI | 6082-1012 | 14433 | 1N4154 |
| CR 103 | DIODE RECTIFIER 1N645 | 6082-1016 | 14433 | 1N645 |
| CR 105 | DIODE 1K455 30PIV 1R 30UA GE | 6092-1010 | 14433 | 1N455 |
| Q 101 | TRANSISTOR 2N3414 | 8210-1290 | 56289 | 2N3414 |
| Q 102 | TRANSISTOR 2N3414 | 8210-1290 | 56289 | 2N3414 |
| Q 103 | TRANSISTOR 2N3414 | 8210-1290 | 56289 | 2N3414 |
| Q 104 | TRANSISTOR 2N3414 | 8210-1290 | 56289 | 2N3414 |
| Q 105 | TRANSISTOR 2N1303 | 8210-1019 | 01295 | 2N1303 |
| Q 106 | TRANSISTOR 2N1303 | 8210-1019 | 01295 | 2N1303 |
| Q 107 | TRANSISTOR 2N3414 | 8210-1290 | 56289 | 2N3414 |
| Q 108 | TRANSISTOR 2N3414 | 8210-1290 | 56289 | 2N3414 |
| R 101 | RES COMP 100 K 5PCT 1/2W | 6100-4105 | 81349 | RCR20G104J |
| R 102 | RES COMP 470 K 5PCT 1/2W | 6100-4475 | 81349 | RCR20G474J |
| R 103 | RES FLM 6.98K 1 PCT 1/2W | 6450-1698 | 81349 | RN65D6981F |
| R 104 | POT WW TRM 2K CHM 10 PCT 10T | 6059-2209 | 80294 | 3067P-1-202 |

NOTE: Composition resistors may be replaced by the same value and power rating in 5% carbon film or 1% metal film.

ELECTRICAL PARTS LIST (cont)

| OSCILLATOR PC BOARD | | | P/N 1538-2710 | | |
|---------------------|-----|------------------------------|---------------|-------|-------------|
| R | 105 | RES COMP 24 K OHM 5PCT 1/4W | 6099-3245 | 81349 | RCR07G243J |
| R | 106 | RES COMP 20 K OHM 5PCT 1/2W | 6100-3205 | 61349 | RCR20G203J |
| R | 107 | RES COMP 2.4 K OHM 5PCT 1/2W | 6100-2245 | 81349 | RCR20G242J |
| R | 108 | RES FLM 14 K 1 PCT 1/2W | 6450-2140 | 61349 | RN6501402F |
| R | 109 | RES COMP 2.2 K 5PCT 1/2W | 6100-2225 | 81349 | RCR20G222J |
| R | 110 | RES COMP 4.7 K 5PCT 1/2W | 6100-2475 | 81349 | RCR20G472J |
| R | 111 | RES FLM 5.9 K 1 PCT 1/2W | 6450-1590 | 81349 | RN65D5901F |
| R | 112 | RES COMP 620 OHM 5PCT 1/2W | 6100-1625 | 81349 | RCR20G621J |
| R | 113 | RES FLM 5.49 K 1 PCT 1/2W | 6450-1549 | 81349 | RN65D5491F |
| R | 114 | POT WW TRM 1K OHM 10 PCT 10T | 6059-2105 | 80294 | 3067P-1-102 |
| R | 115 | RES COMP 2.0 K OHM 5PCT 1/2W | 6100-2205 | 81349 | RCR20G202J |
| R | 116 | RES COMP 10 K 5PCT 1/2W | 6100-3105 | 81349 | RCR20G103J |
| R | 117 | RES COMP 1.0 K 5PCT 1/2W | 6100-2105 | 81349 | RCR20C102J |
| R | 118 | RES COMP 1.0 K 5PCT 1/4W | 6099-2105 | 81349 | RCR07G102J |
| R | 120 | RES COMP 43 K OHM 5PCT 1/2W | 6100-3435 | 81349 | RCR20G433J |
| R | 121 | RES COMP 10 K 5PCT 1/2W | 6130-3105 | 81349 | RCR20G103J |
| R | 122 | RES COMP 4.7 K 5PCT 1/2W | 6100-2475 | 81349 | RCR20G472J |
| R | 123 | RES COMP 4.7 K 5PCT 1/4W | 6099-2475 | 81349 | RCR07G472J |
| R | 124 | RES COMP 22 K 5PCT 1/4W | 6099-3225 | 81349 | RCR07G223J |
| R | 125 | RES COMP 2.2 K 5PCT 1/4W | 6099-2225 | 81349 | RCR07G222J |
| R | 126 | RES COMP 10 K 5PCT 1/2W | 6100-3105 | 81349 | RCR20G103J |
| R | 129 | RES COMP 4.7 K 5PCT 1/2W | 6100-2475 | 81349 | RCR20G472J |
| R | 130 | RES COMP 100 K 5PCT 1/2W | 6100-4105 | 81349 | RCR20G104J |
| R | 131 | RES COMP 100 K 5PCI 1/2W | 6100-4105 | 81349 | RCR20G104J |
| R | 133 | RES COMP 4.7 K 5PCT 1/2W | 6100-2475 | 81349 | RCP20G472J |
| R | 134 | RES COMP 22 K 5PCT 1/2W | 6100-3225 | 81349 | RCP20G223J |

| SWITCH CIRCUIT PC BOARD | | | P/N 1538-2721 | | |
|-------------------------|-----|----------------------------------|---------------|-------|---------------------|
| REFDES | | DESCRIPTION | PART NO. | FMC | MFGR PART NO. |
| C | 201 | CAP MYLAR 1.09 UF 1 PCT 100V | 4860-8010 | 56269 | 410P 1.09 UF 1PCT |
| C | 202 | CAP MYLAR 0.182 UF 1 PCT 100V | 4860-7905 | 56289 | 410P 0.182 UF 1PCT |
| C | 203 | CAP MYLAR 0.0301UF 1 PCT 100V | 4860-7842 | 56289 | 410P 0.0301 UF 1PCT |
| C | 204 | CAP MICA 4320 PF 1PCT 300V | 4600-1350 | 72136 | DM20FC4320PF1PCT4CR |
| C | 205 | CAPACITOR | 1531-4020 | 24655 | 1531-4020 |
| C | 206 | CAPACITOR | 1531-0470 | 24655 | 1531-0470 |
| C | 207 | CAPACITOR | 1538-0441 | 24655 | 1538-0441 |
| R | 201 | POT COMP TRM 50 K OHM 20 PCT 15T | 6001-3509 | 80294 | 3068P-1-503 |
| R | 202 | RES COMP 24 K OHM 5PCT 1/2W D | 6100-3245 | 81349 | RCR20G243J |
| R | 203 | POT COMP TRM 50K OHM 20 PCT 15T | 6001-3509 | 80294 | 3068P-1-503 |
| R | 204 | POT COMP TRM 50K OHM 20 PCT 15T | 6001-3509 | 80294 | 3068P-1-503 |
| R | 205 | RES COMP 10 K 5PCT 1/2W | 6100-3105 | 81349 | RCR20G103J |
| R | 206 | RES COMP 4.7 K 5PCT 1/2W | 6100-2475 | 81349 | RCR20G472J |
| R | 207 | RES FLM 464 K 1 PCT 1/2W | 6450-3464 | 81349 | RN65D4643F |

ELECTRICAL PARTS LIST (cont)

| | | | | | |
|--------|-------------|---------------------------------|---------------|-------|-------------------|
| | | SWITCH CIRCUIT PC BOARD | P/N 1538-2721 | | |
| S | 201 | SWITCH ROTARY ASM | 7890-3940 | 24655 | 7890-3940 |
| | | PC BOARD ASM | P/N 1538-2731 | | |
| C | 301 | CAP ALUM 200-200 UF 50V | 4450-5591 | 24655 | 4450-5591 |
| CR | 301 | DIODE RECTIFIER 1N4003 | 6081-1001 | 14433 | 1N4003 |
| CR | 302 | DIODE RECTIFIER 1N4003 | 6081-1001 | 14433 | 1N4003 |
| CR | 303 | DIODE RECTIFIER 1N4003 | 6081-1001 | 14433 | 1N4003 |
| CR | 304 | DIODE RECTIFIER 1N4003 | 6081-1001 | 14433 | 1N4003 |
| CR | 305 | DIODE RECTIFIER 1N4003 | 6081-1001 | 14433 | 1N4003 |
| CR | 306 | DIODE RECTIFIER 1N645 | 6082-1016 | 14433 | 1N645 |
| Q | 301 | TRANSISTOR 2N1540 | 8210-1540 | 04713 | 2N1540 |
| Q | 302 | TRANSISTOR 2N1303 | 8210-1019 | 01295 | 2N1303 |
| R | 301 | RES COMP 1.0 K 5PCT 1/2W | 6100-2105 | 81349 | RCR20G102J |
| R | 302 | RES COMP 1.8 K 5PCT 1/2W | 6100-2165 | 81349 | RCR20G182J |
| R | 303 | RES COMP 47 K 5PCT 1/2W | 6100-3475 | 81349 | RCR20G473J |
| R | 304 | RES WW MOLDED 3.0 OHM 10 PCT 2W | 6760-9309 | 75042 | 8WH 3 OHM 10PCT |
| | | POWER SUPPLY PC BOARD | P/N 1538-2751 | | |
| C | 501 | CAP MYLAR 1.30UF 1 PCT 100V | 4860-8285 | 56289 | 410P 1.30 UF 1PCT |
| C | 502 | CAP PAPER .022UF 5PCT 600V U | 4510-4001 | 56289 | 416P22356 |
| C | 503 | CAP CER DISC 2200PF 10PCT 500V | 4406-2228 | 72982 | 0871082Z5000222J |
| C | 504 | CAP PAPER .022UF 10PCT 600V | 4510-4000 | 56289 | 416P22396 |
| C | 505 | CAP CER DISC 220PF 5PCT 500V | 4404-1225 | 72982 | 0831082Z5D00221J |
| C | 506 | CAP CER DISC 1000PF 5PCT 500V | 4405-2105 | 72982 | 0801082Z5D00102J |
| C | 509 | CAP ALUM 600-300-300 UF 75V | 4450-5606 | 56289 | 60D 75V |
| C | 511 | CAP CER SQ 0.01UF 80/20PCT 100V | 4403-4100 | 72982 | 8131M100651104Z |
| | | POWER SUPPLY PC BOARD | P/N 1538-2751 | | |
| REFDES | DESCRIPTION | | PART NO. | FMC | MFGR PART NO. |
| CR | 501 | DIODE RECTIFIER 1N645 | 6082-1016 | 14433 | 1N645 |
| CR | 502 | DIODE 1N4154 25P1V IR.1UA SI | 6082-1012 | 14433 | 1N4154 |
| CR | 503 | DIODE RECTIFIER 1N4003 | 6081-1001 | 14433 | 1N4003 |
| CR | 504 | ZENER DIODE 37V 1PCT 1W | 6083-1110 | 24655 | 6083-1110 |
| CR | 505 | DIODE RECTIFIER 1N645 | 6082-1016 | 14433 | 1N645 |
| CR | 507 | RECT MV16A 1600P1V 50MA SI A3H | 6081-1015 | 13327 | MV1LA |
| CR | 508 | DIODE RECTIFIER 1N4003 | 6081-1001 | 14433 | 1N4003 |
| CR | 509 | DIODE RECTIFIER 1N4003 | 6081-1001 | 14433 | 1N4003 |
| CR | 510 | DIODE RECTIFIER 1N4003 | 6081-1001 | 14433 | 1N4003 |
| CR | 511 | DIODE RECTIFIER 1N4003 | 6081-1001 | 14433 | 1N4003 |
| CR | 516 | ZENER 1N965B 15V 5PCT .4W | 6083-1015 | 14433 | 1N9658 |
| CR | 517 | ZENER 1N748A 3.9V 5PCT .4W | 6083-1002 | 14433 | 1N748A |
| L | 501 | CHOKE MOLDED 1.8 UH 10PCT | 4300-1100 | 99800 | 1537-18 |

ELECTRICAL PARTS LIST (cont)

| POWER SUPPLY PC BOARD | | P/N 1538-2751 | | |
|-----------------------|--------------------------------|---------------|-------|------------------|
| REFDES | DESCRIPTION | PART NO. | FMC | MFGR PART NO. |
| Q 501 | TRANSISTOR 2N1305 | 8210-1305 | 01295 | 2N1305 |
| Q 502 | TRANSISTOR 2N3414 | 8210-1290 | 56289 | 2N3414 |
| Q 503 | TRANSISTOR 2N3414 | 8210-1290 | 56289 | 2N3414 |
| Q 504 | TRANSISTOR 2N3414 | 8210-1290 | 56289 | 2N3414 |
| Q 506 | TRANSISTOR 2N697 | 8210-1040 | 04713 | 2N697 |
| Q 507 | TRANSISTOR 2N3414 | 8210-1290 | 56289 | 2N3414 |
| Q 508 | TRANSISTOR 2N697 | 8210-1040 | 04713 | 2N697 |
| Q 509 | TRANSISTOR 2N1305 | 8210-1305 | 01295 | 2N1305 |
| Q 510 | TRANSISTOR 2N1546 | 8210-1073 | 04713 | 2N1546 |
| R 501 | RES COMP 47 K 5PCT 1/2W | 6100-3475 | 81349 | RCR20G473J |
| R 502 | RES COMP 3.3K 5PCT 1/2W | 6100-2335 | 81349 | RCR20G332J |
| R 503 | RES COMP 91 OHM 5PCT 1/2W | 6100-0915 | 81349 | RCR20G910J |
| R 504 | RES WW AX LEAD 82 OHM 5 PCT 3W | 6680-0825 | 75042 | AS-2 82 OHM 5PCT |
| R 505 | RES COMP 47 OHM 5PCT 1/21W | 6100-0475 | 81349 | RCR20G470J |
| R 506 | RES COMP 1.0 K 5PCT 1/2W | 6100-2105 | 81349 | RCR20G102J |
| R 507 | RES COMP 2.2 K 5PCT 1/2W | 6100-2225 | 81349 | RCR20G222J |
| R 508 | RES FLM 34 K 1 PCT 1/2W | 6450-2340 | 81349 | RN6503402F |
| R 509 | RES COMP 2.2 K 5PCT 1/2W | 6100-2225 | 81349 | RCR20G222J |
| R 510 | RES COMP 1.0 K 5PCT 1/2W | 6100-2105 | 81349 | RCR20G102J |
| R 512 | RES COMP 47 K 5PCT 1/2W | 6100-3475 | 81349 | RCR20G473J |
| R 513 | RES COMP 10 K 5PCT 1/2W | 6100-3105 | 81349 | RCR20G103J |
| R 514 | RES COMP 47 K 5PCT 1/2k | 6100-3475 | 81349 | RCR20G473J |
| R 515 | RES COMP 22 K 5PCT 1/2W | 6100-3225 | 81349 | RCR20G223J |
| R 518 | RES COMP 18 K 5PCT 1/2W | 6100-3185 | 81349 | RCR20G183J |
| R 519 | RES COMP 18 K 5PCT 1/2W | 6100-3185 | 81349 | RCR20G183J |
| R 520 | RES COMP 1.0 K 5PCT 1/2W | 6120-2105 | 61349 | RCR42G102J |
| R 521 | RES COMP 27 OHM 5PCT 1/2W | 6100-0275 | 81349 | RCR20G270J |
| R 522 | RES COMP 620 K OHM 5PCT 1/2W | 6100-4625 | 81349 | RCR20G624J |
| R 523 | RES COMP 10 K 5PCT 1/2W | 6100-3105 | 81349 | RCR20G103J |
| R 525 | RES COMP 27 K 5PCT 1/2W | 6100-3275 | 81349 | RCR20G273J |
| R 526 | RES COMP 3.3 K 5PCT 1/2W | 6100-2335 | 81349 | RCR20G332J |
| R 529 | RES COMP 270 OHM 5PCT 1/2W | 6100-1275 | 81349 | RCR20G271J |
| T 501 | TRANSFORMER POWER | 0345-4130 | 24655 | 0345-4130 |
| T 502 | TRANSFORMER INDUCTOR | 0746-4450 | 24655 | 0746-4450 |

NOTE; The number appearing on the foil side is not the part number. The dot on the foil at the transistor socket indicates the collector lead.

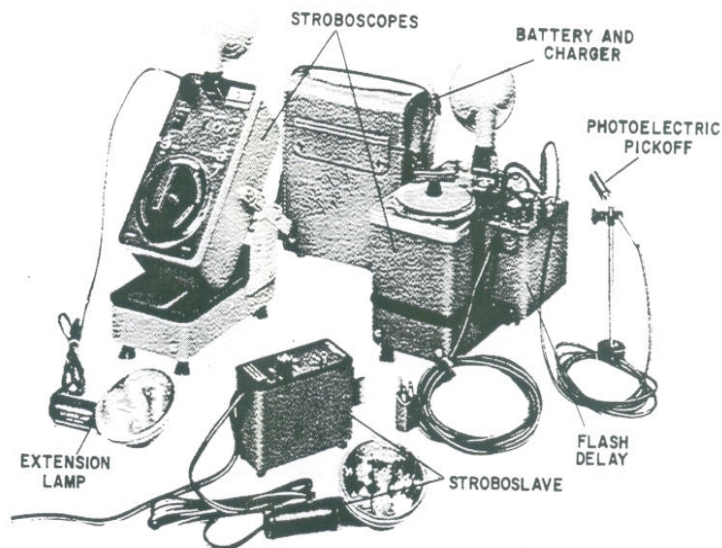

Some of the many accessory instruments available for use with the stroboscopes.

Type 1538-P4 High-Intensity-Flash Capacitor (See Figure 2-14)

With the Type 1538-P4 High-Intensity-Flash Capacitor connected to the Type 1538 (refer to paragraph 2.11.7), it is possible to produce a single brilliant flash of 44 million beam candles with an 8-ms duration. This accessory should be used when the object being photographed is operating at extremely high speed or in unavoidably high ambient light.



Type 1538-P2 Extension Lamp

The Type 1538-P2 Extension Lamp consists of a lamp-and-reflector assembly identical to that on the Strobotac, with a six-foot cord and plug. This lightweight lamp assembly makes a convenient accessory for observing the motion of object; in those hard-to-reach places.

The reflector is identical to that of the 1538 Strobotac. The entire assembly (excluding the connecting cable) is 7 inches (180 mm) long; its weight, (including the cord) is 8 ounces (0.3 kg). Custom cables of any length can be ordered.

APPENDIX

Type 1539-A Stroboslave

The Type 1539 Stroboslave is an auxiliary light-source that will produce a flashing light with output characteristics that are similar to the Type 1531 Strobotac. This compact stroboscope will flash on command when triggered from a contact closure or from a variety of equipment including the Type 1531 or the Type 1538 Strobotacs.

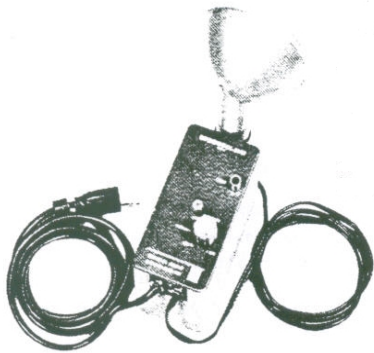

SPECIFICATIONS

Flashing-Rate Ranges: 0 to 700, 0 to 400, 0 to 25,000 flashes per min on high-, medium-, and low-intensity ranges, respectively.

Flash Duration: Approx 0.8, 1.2, and 3ms, measured at 1/3 peak intensity, for the low-, medium-, and high-intensity ranges, respectively.

Peak Light Intensity: Typically 0.6, 3.5, and 11 million beam candles (0.6, 3.5, and 11 X 10⁶ lux measured at 1-m distance at the beam center), for low-, medium-, and high-intensity ranges, respectively.

For single flash, 18 million beam candles at 1 meter.

Reflector Beam Angle: 10° at half-intensity points.

External Triggering: Either a switch closure across the input jack terminals or a 2-V (peak) positive pulse.

Power Required: 100 to 125 or 195 to 250 V, 50 to 400 c/s, 16 W.

Accessories Supplied: Phone plug for input.

Accessories Available: Type 1537-A Photoelectric Pickoff, Type 1531-P2 Flash Delay (with a Type 1536-A Photoelectric Pickoff).

Mechanical Data:

| Width | | Height | | Depth | | Net Weight | | Shipping Weight | |
|-------|----|--------|-----|-------|-----|------------|-----|-----------------|-----|
| in | mm | in | mm | in | mm | lb | kg | lb | kg |
| 2½ | 64 | 8 3/8 | 215 | 4 1/8 | 105 | 2 3/4 | 1.3 | 8 | 3.7 |

Type 1531-P2 Flash Delay

The Type 1531-P2 Flash Delay provides a continuously adjustable time-delay between an external triggering device and a Stroboscope. The triggering device can be an oscillator, photocell or other type of transducer.

A typical combination of flash delay, photoelectric pickoff and stroboscope can be used for visual observation and analysis of repetitive motion whose period is not constant. The flash delay also provides means for precise synchronization of camera shutter, stroboscopic flash, and objects moving at irregular speeds, for high-speed photography or other purposes.



SPECIFICATIONS

Time-Delay Range: Approximately 100 ms to 0.8 ms in three ranges.

Output Pulse: >13 V available for triggering the Type 1531-A and 1538-A Strobotac® electronic stroboscopes and the Type 1539-A Stroboslave.

Sensitivity: As little as 0.3V input will produce sufficient output to trigger the stroboscope.

Input: Phone jack for triggering; jack for camera synchronization.

Accessories Available: Type 1536-A Photoelectric Pickoff.

Power Required: 105 to 125 or 210 to 250 V, 50 to 400 c/s, 5 W with Type 1536-A connected.

Mechanical Data:

| Width | | Height | | Depth | | Net Weight | | Shipping Weight | |
|-------|-----|--------|----|-------|----|------------|----|-----------------|-----|
| in | mm | in | mm | in | mm | lb | kg | lb | kg |
| 5 1/8 | 135 | 3 1/8 | 80 | 3 3/4 | 96 | 2 | 1 | 5 | 2.3 |

Type 1536-A Photoelectric Pickoff

The Type 1536 Photoelectric Pickoff contains a light source, an optical system and a photocell that produces a pulse when light from a moving object is reflected back to the photocell. This output pulse is fed through a Type 1531-P2 Flash Delay, and then used to trigger a Stroboscope. With this combination of instruments, the motion of objects rotating at irregular speeds can be analyzed visually or by photographic means.

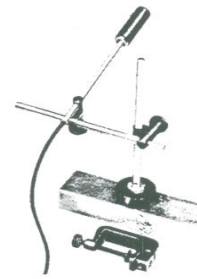

SPECIFICATIONS

Maximum Pulse Rate: Approximately 2500 pulses/s as limited by the 200- μ s time constant of the photocell and cable combination.

Power Required: 20 to 28 V dc, 40 mA. Power is supplied by the Type 1531-P2 Flash Delay or the Type 1150-B (or Type 1151-A) Digital Frequency Meter.

Accessories Supplied: 10-ft roll of 3/8-in black tape; 10-ft roll of 3/8-in silver tape; carrying case.

Mounting: C-clamp (capacity 1 5/16 in, flat or round) or 1 1/2-in magnet, both supplied. Net Weight: 1 1/4 lb (0.6 kg).

Shipping Weight: 4 lb (1.9 kg).

Type 1537-A PHOTOELECTRIC PICKOFF

In appearance, the Type 1537 Photoelectric Pickoff is similar to the Type 1536. The Type 1537, however, has no light source; the photosensitive element is a silicon light-activated switch. The output from this transducer will directly trigger the Type 1538 Strobotac or the Type 1539 Stroboslave.

SPECIFICATIONS

Operating Rate: Greater than 2500 pulses/s.
Power Required: 3 to 25 V dc; 0 to 100 mA depending on operating rate. Power is supplied by instrument with which it is used.

Accessories Supplied: 10-ft roll of 3/8-in black tape, 10-ft roll of 3/8-in silver tape, carrying case.

Mounting: C-clamp (capacity 1 5/16 in, flat or round) or 1 1/2-in magnet, both supplied.

Net Weight: 1 1/2 lb (0.7 kg).

Shipping Weight: 4 1/2 lb (2.1 kg).